

Grove RT540E

Product Guide



Features

- 35 t (40 USt) capacity
- 9,8 m – 31 m (32 ft – 102 ft) four-section full power boom
- 7,9 m – 13,7 m (26 ft – 45 ft) offsettable telescopic swingaway extension
- Dual-axis electric joystick controllers
- Full frame decking
- Full vision cab design
- 119 kW (160 hp) Cummins diesel engine (Tier IV)



Features



Boom shape

The RT540E is equipped with a 9,8 m - 31 m (32 ft - 102 ft) four-section full power boom. The boom incorporates a rectangular boom shape made from 100 k.s.i. steel which eliminates weight and maximizes structural capacities.

CraneSTAR

CraneSTAR is an exclusive and innovative crane asset management system that helps improve your profitability and reduce costs by remotely monitoring critical crane data. Visit www.cranestar.com for more information.



Tip height

The RT540E offers a 7,9 m - 13,7 m (26 ft - 45 ft) offsettable telescopic swingaway providing a maximum tip height of 47 m (154 ft) with 13,7 m (45 ft).



Cab

The Full Vision cab with tilt-telescoping steering wheel, dual-axis controllers, hot water heat and air conditioning provide all day comfort for the operator.



Contents

Specifications	4
Dimensions and weights	7
Working range	8
Load charts	9
Load handling	14

Specifications

Superstructure

Boom

9,8 m - 31 m (32 ft - 102 ft) four-section, synchronized full power boom.

Maximum tip height: 33,6 m (110 ft).



* Optional telescopic swingaway extension

7,9 m - 13,7 m (26 ft - 45 ft) offsettable telescopic lattice swingaway extension. Offsets at 0°, 15° and 30°. Stows alongside base boom section.

Maximum tip height 47 m (154 ft).



Boom nose

Four nylatron sheaves mounted on heavy duty tapered roller bearings with removable pin-type rope guards. Quick reeve type boom nose.



Boom elevation

One double-acting hydraulic cylinder with integral holding valve provides elevation from -3° to +78°.



Load moment and anti-two block system

Standard “Graphic Display” load moment and anti-two block system with audio-visual warning and control lever lockout. These systems provide electronic display of boom angle, length, radius, tip height, relative load moment, maximum permissible load, load indication and warning of impending two-block condition. The standard Work Area Definition System allows the operator to pre-select and define safe working areas. If the crane approaches the pre-set limits, audio-visual warnings aid the operator in avoiding job-site obstructions.



Cab

Full-vision, all-steel fabricated with acoustical lining and tinted safety glass throughout. Deluxe seat incorporates armrest-mounted hydraulic single-axis controllers. Tilt/telescoping steering wheel with various controls incorporated into the steering column. Other standard features include: hot water heater, cab circulating air fan, sliding side and rear windows, sliding skylight with electric wiper and sunscreen, electric windshield wash/wipe, fire extinguisher, seat belt, air conditioning, and dual cab mounted work light.



Swing

Single speed, planetary swing drive with foot applied multi-disc wet brake. Spring applied, hydraulically released swing brake. Single position mechanical house lock, operated from cab.

Maximum speed: 2 rpm.



Counterweight

4305 kg (9490 lb) pinned to superstructure.



Hydraulic system

Two main pumps, one (1) piston and one (1) gear with a combined capacity of 316,5 LPM (83.6 GPM). Maximum operating pressure: 275,7 bar (4000 psi). Three section pressure compensated valve bank. Return line type filter with full flow by-pass protection and service indicator. Replaceable cartridge with micron filtration rating of 5/12/16. 396 L (104.6 gal) hydraulic reservoir. System pressure test ports.



Hoist specifications (HP15C-17G) main and auxiliary hoist

Planetary reduction with automatic spring applied multi-disc wet brake. Electronic hoist drum rotation indicators, and hoist drum cable followers.

Maximum single line pull:

1st layer: 5280 kg (11,640 lb)

3rd layer: 4323 kg (9530 lb)

5th layer: 3656 kg (8060 lb)

Maximum permissible line pull:

5280 kg (11,640 lb) with 6 x 37 class rope

5280 kg (11,640 lb) with 35 x 7 class rope

Maximum single line speed: 136 m-min (445 fpm)

Rope construction:

6 x 36 EIPS IWRC, Special Flexible

35 x 7 Flex-X, Rotation Resistant

Rope diameter: 16 mm (5/8 in)

Rope length:

Main hoist: 137 m (450 ft)

Auxiliary hoist: 137 m (450 ft)

Maximum rope stowage: 181 m (596 ft)

Specifications

Carrier



Chassis

Box section frame fabricated from high-strength, low alloy steel. Combination lift/tie-down/towing lugs.



Outrigger system

Four hydraulic telescoping single-stage double box beam outriggers with inverted jacks and integral holding valves. Three position setting, 0%, 50% and fully extended. All steel fabricated quick release type outrigger floats, 362 mm (14.25 in) square.

Maximum outrigger pad load 26 300 kg (58,000 lb). Outrigger monitoring system comes standard. Outrigger monitoring system comes standard (required in North America and Canada).



Outrigger controls

Controls and crane level indicator located in cab.



Engine (Tier IV)

Cummins QSB 6.7 L diesel, six cylinders, turbocharged with Cummins Diesel Oxidation Catalyst filter/muffler. Meets emissions per U.S.E.P.A. Tier IV and E.U. Stage III B. 119 kW (160 bhp) at 2500 rpm. Maximum torque: 732 N-m (540 ft lb) at 1500 rpm.

Fuel requirement: Maximum of 15 ppm sulphur content (Ultra Low Diesel Fuel).

Note: Tier IV engine Required in North American and European Union countries.



Engine (Tier III)

Cummins QSB 6.7 L diesel, six cylinders, 119 kW (160 bhp) (Gross) at 2500 rpm.

Maximum torque: 732 Nm (540 ft-lb) at 1500 rpm.



Fuel tank capacity

220 L (58 gal)



Transmission

Range-shift 6-speed (3 speeds x 2 range, both forward and reverse). Front axle disconnect for 4 x 2 travel.



Electrical system

Four (4) 12V maintenance free batteries. 24V starting and lighting. Battery disconnect. Full CanBus diagnostic system.



Drive

4 x 4



Steering

Fully independent power steering.

Front: full hydraulic steering wheel controlled.

Rear: Full hydraulic switch controlled.

Provides infinite variations 4-main steering modes: front only, rear only, crab, and coordinated.

Rear steer indicator.

Outside turning radius: 5,8 m (19.1 ft)

Inside turning radius: 4 m (13.1 ft)



Axles

Front: Drive/steer with differential and planetary reduction hubs rigid mounted to frame.

Rear: Drive/steer with differential and planetary reduction hubs pivot mounted to frame.



Oscillation lockouts

Automatic full hydraulic lockouts on rear axle permits 25,4 cm (10 in) oscillation only with boom centered over the front.



Brakes

Full hydraulic split circuit disc-type brakes operating on all wheels. Spring-applied, hydraulically released parking brake mounted on front axle.



Tires

Standard 20.5 x 25-24 bias ply



Lights

Full lighting including turn indicators, head, tail, brake and hazard warning lights.

Specifications

Carrier continued



Maximum speed

40 km/h (25 mph) at 2500 rpm



Gradeability (theoretical)

119% (at engine stall).

(Based on 28 365 kg [62,532 lb] GVW) 20.5 x 25 tires 31 m (102 ft) main boom, plus 13,7 m (45 ft) telescopic swingaway, 4305 kg (9490 lb) counterweight, 35 t (40 USt) hook block and 6,8 t (7.5 USt) headache ball.

Miscellaneous standard equipment

Full width steel fenders, full length steel decking with anti-skid, dual rear view mirrors, hook-block tiedown, electronic back-up alarm, light package, front stowage well, tachometer/hourmeter, rear wheel position indicator, 36,000 Btu hot water cab heater, 28,500 Btu air conditioning, hoist mirrors, engine distress A/V warning system, combination lift/tie-down/towing lugs, coolant sight level indicator, CraneSTAR asset management system.

*Optional equipment

- ▶ Auxiliary Hoist Package: Includes model HP15C-17G auxiliary hoist with electronic hoist drum rotation indicator, hoist drum cable follower, 137 m (450 ft) of 16 mm (5/8 in) 35 x 7 class wire rope and auxiliary sheave boom nose.
- ▶ Auxiliary Light and Convenience Package: Includes cab mounted amber flashing light, hoist mounted work lights, and dual base boom mounted floodlights, LMI light bar (in cab), rubber mat for stowage trough.
- ▶ 360° NYC style mechanical swing lock
- ▶ Rear Pintle hook
- ▶ Cab-controlled cross axle differential locks (front and rear)
- ▶ PAT event recorder download kit

Dimensions and weights

Dimensions												
	Tire size	A	B	C	D	E	F	G	H	J	K	L
2-wheel steer	20.5 x 25	13 563 mm (534 in)	13 328 mm (525 in)	10 899 mm (429 in)	10 236 mm (403 in)	10 007 mm (394 in)	8138 mm (320 in)	7021 mm (276 in)	2055 mm (81 in)	25.0°	23.0°	2606 mm (103 in)
	16.0 x 25	13 563 mm (534 in)	13 328 mm (525 in)	10 899 mm (429 in)	10 185 mm (401 in)	9981 mm (393 in)	8138 mm (320 in)	7021 mm (276 in)	2093 mm (82 in)	26.0°	24.0°	2536 mm (100 in)
4-wheel steer	20.5 x 25	9797 mm (386 in)	9490 mm (374 in)	6732 mm (265 in)	6061 mm (239 in)	5832 mm (230 in)	4000 mm (157 in)	3498 mm (137 in)	2055 mm (81 in)	25.0°	23.0°	2606 mm (103 in)
	16.0 x 25	9797 mm (386 in)	9490 mm (374 in)	6732 mm (265 in)	6010 mm (237 in)	5806 mm (229 in)	4000 mm (157 in)	3498 mm (137 in)	2093 mm (82 in)	26.0°	24.0°	2536 mm (100 in)

- Notes:**
- All dimensions are for reference only
 - Boom elevation is -3° to +76°
 - Dimensions shown are based on 20.5 x 25 tires. Add 35.4 mm (1.35 in) for 16.0 x 25 tires

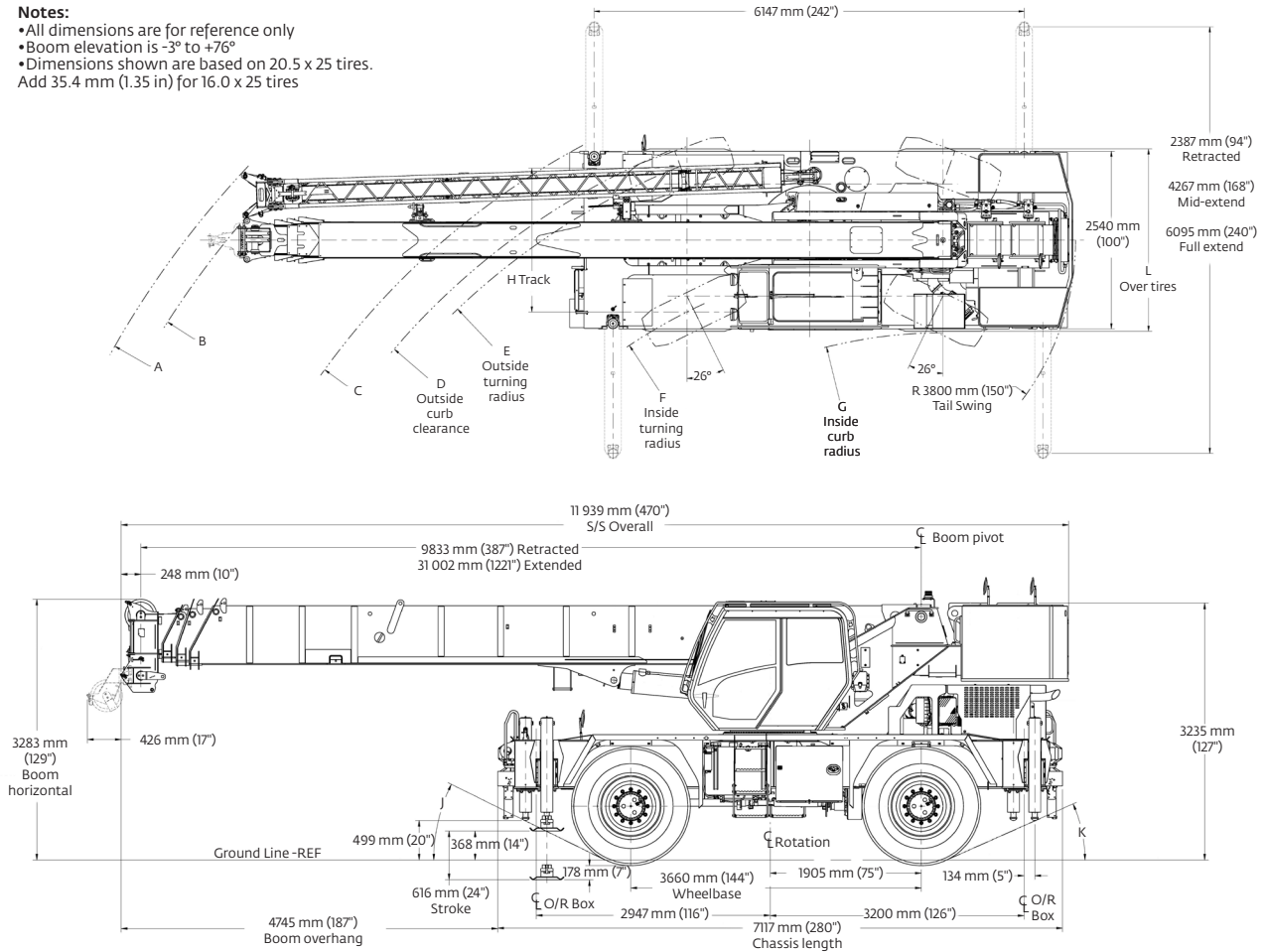

	GVW		Front		Rear	
	kg	(lb)	kg	(lb)	kg	(lb)
RT540E basic machine: Including 31 m (102 ft) main boom, main hoist with 137 m (450 ft) of rope, full counterweight + IPO 6, 8 t (7.5 USt) headache ball, and 35 t (40 USt) hook block	27 693	(61,052)	13 239	(29,186)	14 454	(31,866)
Add: Auxiliary hoist + 137 m (450 ft) of 35 x 7 hoist cable and auxiliary boom nose ILO IPO counterweight	27 915	(61,540)	13 320	(29,364)	14 595	(32,176)
Add: 7,9 m - 13,7 m (26 ft - 45 ft) telescopic boom extension + extension hangers	28 775	(63,438)	14 747	(32,511)	14 028	(30,927)

Working range

102 ft main boom + 26 ft - 45 ft extension

(Boom deflection not shown) D6-829-103927

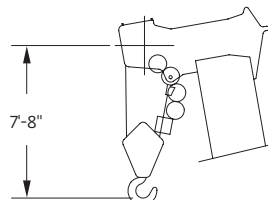
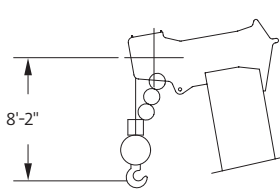
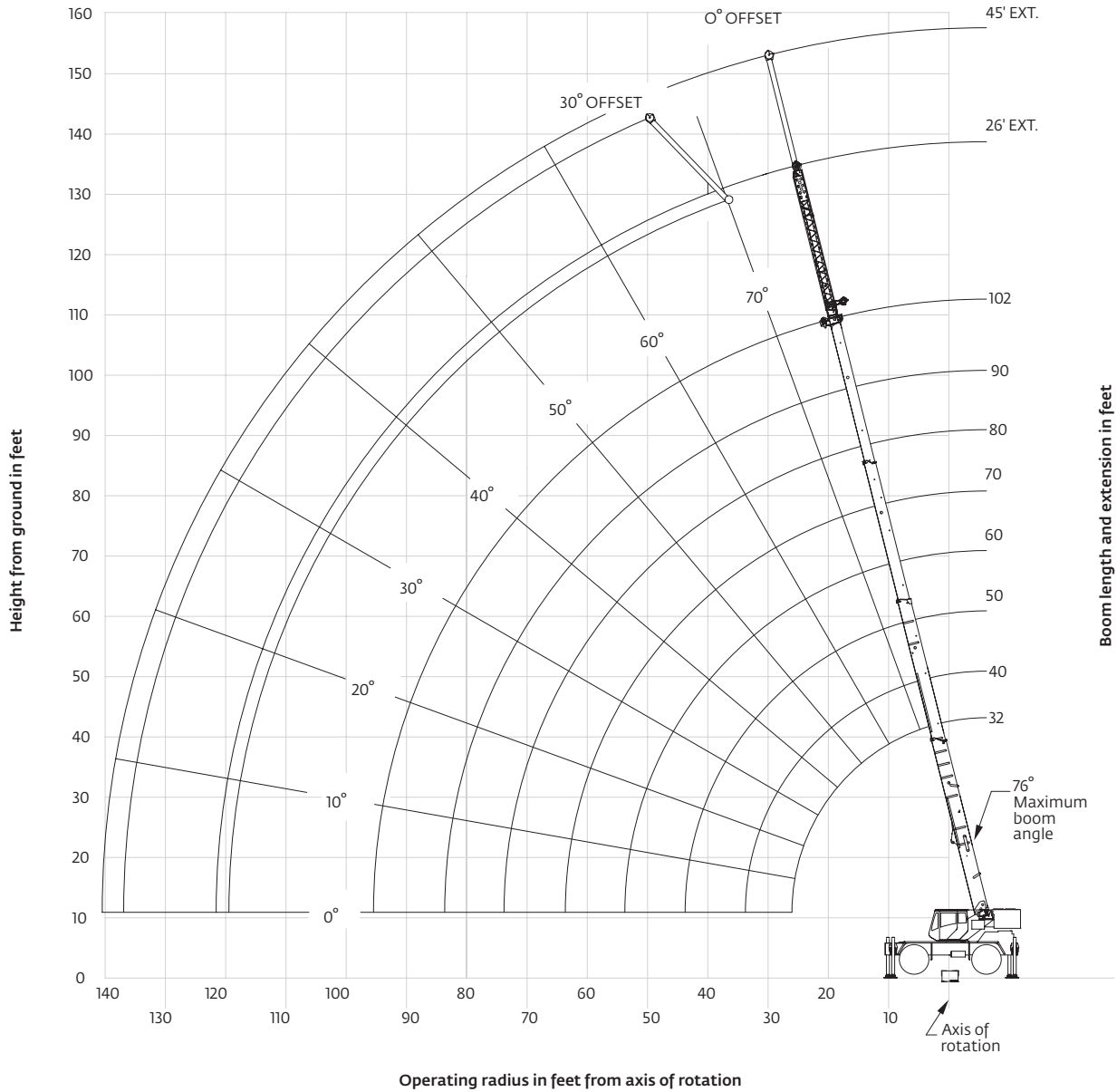





Dimensions are for largest Grove furnished hook block and headache ball, with anti-two block activated.

THIS CHART IS ONLY A GUIDE AND SHOULD NOT BE USED TO OPERATE THE CRANE.

The individual crane's load chart, operating instructions and other instructional plates must be read and understood prior to operating the crane

Load chart

23 ft 4 in spread

 Pounds

Feet	Main boom length in feet							
	32	40	50	60	70	80	90	102
8	80,000 (69)							
10	72,200 (65)	50,700 (70.5)	48,500 (75)					
12	61,000 (61)	50,700 (67.5)	48,500 (72.5)	*46,400 (76)				
15	47,950 (54)	48,400 (62.5)	48,500 (69)	44,300 (73)	*38,700 (76)			
20	34,550 (41)	35,000 (53.5)	35,400 (62.5)	35,300 (67.5)	31,000 (71.5)	29,700 (74)	*22,000 (76)	
25	26,300 (20.5)	26,800 (43.5)	27,200 (55.5)	27,400 (62.5)	25,800 (67)	24,600 (70.5)	22,000 (73)	*18,500 (76)
30		21,250 (30)	21,650 (47.5)	21,850 (56.5)	21,800 (62.5)	20,800 (66.5)	18,350 (69.5)	17,500 (73)
35			17,650 (38.5)	17,900 (50.5)	18,050 (57.5)	17,800 (62.5)	15,600 (66)	15,200 (70)
40			14,400 (26.5)	14,450 (43.5)	14,650 (52.5)	14,800 (58.5)	13,500 (62.5)	13,200 (66.5)
45				11,650 (35)	11,800 (46.5)	11,900 (54)	11,750 (59)	11,600 (63.5)
50				9480 (24.5)	9680 (40.5)	9770 (49)	9780 (55)	9790 (60.5)
55					7970 (33)	8080 (44)	8110 (51)	8130 (57)
60					6600 (23)	6720 (38)	6770 (46.5)	6800 (53.5)
65						5590 (31)	5670 (42)	5710 (49.5)
70						4640 (21.5)	4740 (36)	4800 (45.5)
75							3940 (29.5)	4040 (41)
80							3250 (21)	3360 (36)
85								2770 (30.5)
90								2250 (23)
95								1800 (9.5)
Minimum boom angle (°) for indicated length (no load)								
								0
Maximum boom length (ft) at 0° boom angle (no load)								
								102
NOTE: () Boom angles are in degrees. #LMI operating code. Refer to LMI manual for operating instructions. *This capacity is based on maximum boom angle.								
Lifting capacities at zero degree boom angle								
Boom angle	Main boom length in feet							
	32	40	50	60	70	80	90	102
0°	24,950 (26)	18,100 (33.8)	12,150 (43.8)	8,180 (53.8)	5740 (63.8)	4030 (73.8)	2800 (83.8)	1760 (95.5)

NOTE: () Reference radii in feet.

A6-829-104278

Load chart

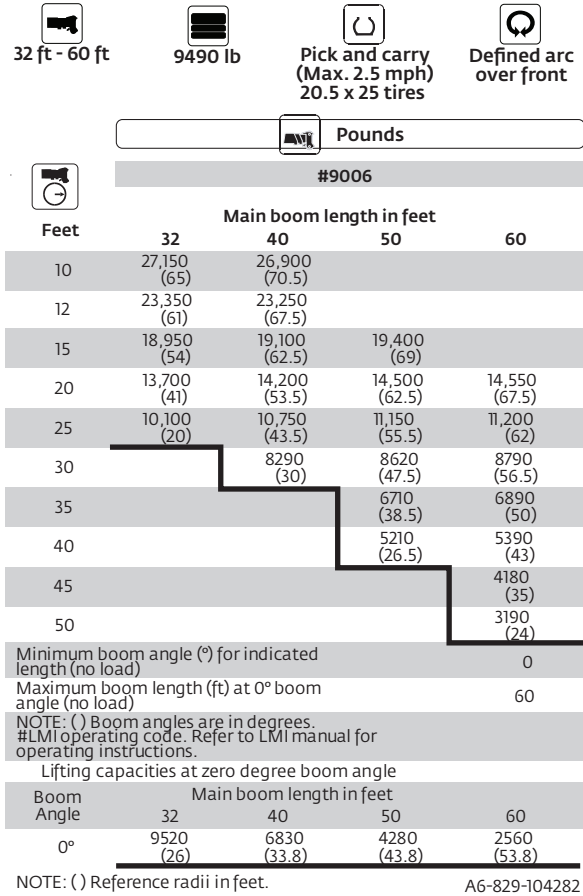
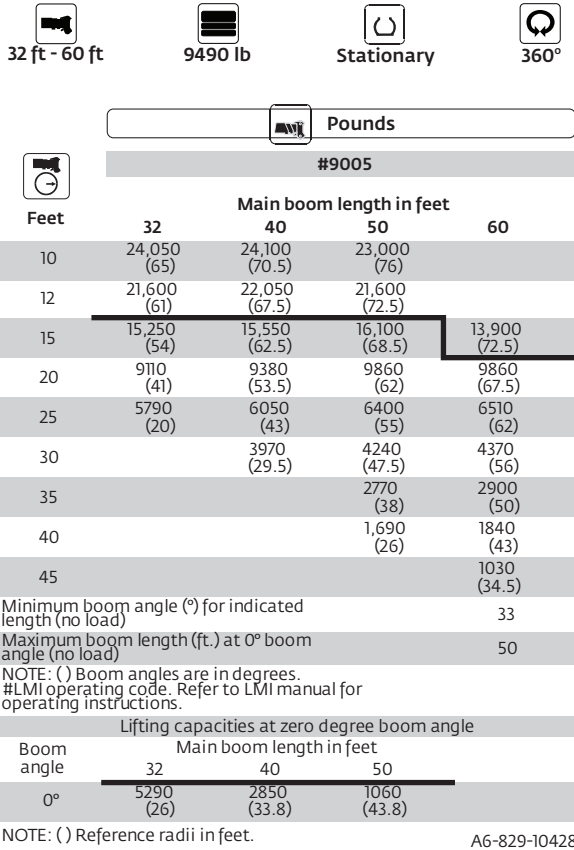

Notes to all rubber capacity charts:

- 1.Capacities are in pounds and do not exceed 75% of tipping loads as determined by test in accordance with SAE J765.
- 2.Capacities are applicable to machines equipped with 20.5 x 25 (24 ply) tires at 75 psi cold inflation pressure, and 16.00 x 25 (28 ply) tires at 100 psi cold inflation pressure.
- 3.Capacities appearing above the bold line are based on structural strength and tipping should not be relied upon as a capacity limitation.
- 4.Capacities are applicable only with machine on firm level surface.
- 5.On rubber lifting with boom extensions not permitted.
- 6.For pick and carry operation, boom must be centered over front of machine, mechanical swing lock engaged and load restrained from swinging. When handling loads in the structural range with capacities close to maximum ratings, travel should be reduced to creep speeds.
- 7.Axle lockouts must be functioning when lifting on rubber.
- 8.All lifting depends on proper tire inflation, capacity and condition. Capacities must be reduced for lower tire inflation pressures. See lifting capacity chart for tire used. Damaged tires are hazardous to safe operation of crane.
- 9.Creep - Not over 200 ft of movement in any 30 minute period and not exceeding 1 mph.

THIS CHART IS ONLY A GUIDE AND SHOULD NOT BE USED TO OPERATE THE CRANE.

Load chart

32 ft - 102 ft
 9490 lb
 14 ft spread
 50%
 360°

		Pounds							
		#4001							
		Main boom length in feet							
Feet	32	40	50	60	70	80	90	102	
8	77,000 (69)								
10	66,250 (65)	50,700 (70.5)	48,500 (75)						
12	57,950 (61)	50,700 (67.5)	48,500 (72.5)	46,400 (76)					
15	46,300 (54)	44,200 (62.5)	41,800 (69)	39,550 (73)	37,550 (76)				
20	27,100 (41)	27,700 (53.5)	27,050 (62.5)	25,950 (67.5)	24,950 (71.5)	24,000 (74)	22,000 (76)		
25	17,650 (20.5)	18,250 (43.5)	18,500 (55.5)	18,450 (62.5)	18,050 (67)	17,450 (70.5)	16,950 (73)	16,350 (76)	
30		12,850 (30)	13,200 (47.5)	13,300 (56.5)	13,550 (62.5)	13,250 (66.5)	12,950 (69.5)	12,500 (73)	
35			9790 (38.5)	9910 (50.5)	10,150 (57.5)	10,250 (62.5)	10,100 (66)	9830 (70)	
40			7400 (26.5)	7520 (43.5)	7770 (52.5)	7910 (58.5)	7950 (62.5)	7820 (66.5)	
45				5760 (35)	5970 (46.5)	6150 (54)	6180 (59)	6190 (63.5)	
50				4410 (24.5)	4590 (40.5)	4750 (49)	4820 (55)	4850 (60.5)	
55					3500 (33)	3630 (44)	3710 (51)	3780 (57)	
60						2610 (23)	2730 (38)	2810 (46.5)	2890 (53.5)
65							1980 (31)	2070 (42)	2150 (49.5)
70								1350 (21.5)	1440 (36)
75									1000 (41)

Minimum boom angle (°) for indicated length (no load) 0 21 36
 Maximum boom length (ft) at 0° boom angle (no load) 80

NOTE: () Boom angles are in degrees.
 #LMI operating code. Refer to LMI manual for operating instructions.
 *This capacity is based on maximum boom angle.

Lifting capacities at zero degree boom angle					
Boom angle	Main boom length in feet				
	32	40	50	60	70
0°	16,300 (26)	10,150 (33.8)	6030 (43.8)	3580 (53.8)	2050 (63.8)

NOTE: () Reference radii in feet A6-829-104279

32 ft - 102 ft
 9490 lb
 7.8 ft spread
 0%
 360°

		Pounds							
		#8001							
		Main boom length in feet							
Feet	32	40	50	60	70	80	90	102	
8	51,950 (69)								
10	37,800 (65)	35,900 (70.5)	33,600 (75)						
12	29,050 (61)	28,100 (67.5)	26,600 (72.5)	25,150 (76)					
15	20,850 (54)	20,450 (62.5)	19,750 (69)	18,850 (73)	18,000 (76)				
20	12,500 (41)	13,050 (53.5)	12,950 (62.5)	12,600 (67.5)	12,150 (71.5)	11,700 (74)	11,250 (76)		
25	7950 (20.5)	8460 (43.5)	8700 (55.5)	8760 (62.5)	8580 (67)	8300 (70.5)	8050 (73)	7720 (76)	
30		5610 (30)	5890 (47.5)	6000 (56.5)	6110 (62.5)	5980 (66.5)	5840 (69.5)	5600 (73)	
35			3980 (38.5)	4090 (50.5)	4350 (57.5)	4270 (62.5)	4200 (66)	4060 (70)	
40				2600 (26.5)	2710 (43.5)	2940 (52.5)	2970 (58.5)	2940 (62.5)	2850 (66.5)
45					1670 (35)	1860 (46.5)	1960 (54)	1950 (59)	1890 (63.5)
50						1020 (40.5)	1160 (49)	1160 (55)	1110 (60.5)

Minimum boom angle (°) for indicated length (no load) 0 33 44 51 57
 Maximum boom length (ft) at 0° boom angle (no load) 60

NOTE: () Boom angles are in degrees.
 #LMI operating code. Refer to LMI manual for operating instructions.
 *This capacity is based on maximum boom angle.

Lifting capacities at zero degree boom angle			
Boom angle	Main boom length in feet		
	32	40	50
0°	7230 (26)	4060 (33.8)	1790 (43.8)

NOTE: () Reference radii in feet A6-829-104280

Load chart



Pounds		
26 ft LENGTH		
Feet	#4051 0° OFFSET	#4053 30° OFFSET
35	⁸²⁰⁰ (76)	
40	7240 (72.5)	
45	5780 (70)	⁵⁷⁸⁰ (76)
50	4610 (67.5)	5740 (72.5)
55	3650 (65)	4650 (70)
60	2850 (62.5)	3720 (67.5)
65	2140 (60)	2900 (64.5)
70	1540 (57.5)	2210 (62)
75	1030 (54.5)	1620 (59)
80		1100 (56)
Min. boom angle for indicated length (no load)		
	51.5°	53°
Max. boom length at 0° boom angle (no load)		
	60 ft	

NOTE: () Boom angles are in degrees.
#LMI operating code. Refer to LMI manual for instructions.
^{*}This capacity based on maximum boom angle.

A6-829-104330

Boom extension capacity notes:

1. All capacities above the bold line are based on structural strength of boom extension.
2. 26 ft fixed extension lengths may be used for single line lifting service.
3. Radii listed are for a fully extended boom with the boom extension erected. For main boom lengths less than fully extended, the rated loads are determined by boom angle. Use only the column which corresponds to the boom extension length and offset for which the machine is configured. For boom angles not shown, use the rating of the next lower boom angle.

Warning: Operation of this machine with heavier loads than the capacities listed is strictly prohibited. Machine tipping with boom extension occurs rapidly and without advance warning.

4. Boom angle is the angle above or below horizontal of the longitudinal axis of the boom base section after lifting rated load.
5. Capacities listed are with outriggers properly extended and vertical jacks set only.
6. When lifting over the main boom nose with 26 ft fixed extension erected, the outriggers must be fully extended or 50% extended (14 ft spread).



Pounds						
Feet	26 ft LENGTH			45 ft LENGTH		
	#4021 0° OFFSET	#4022 15° OFFSET	#4023 30° OFFSET	#4041 0° OFFSET	#4042 15° OFFSET	#4043 30° OFFSET
35	⁹¹²⁰ (76)					
40	7240 (72.5)	⁷⁷⁷⁰ (76)		⁵²⁵⁰ (76)		
45	5780 (70)	6460 (72)	⁶⁰³⁰ (76)	5250 (73.5)		
50	4610 (67.5)	5200 (69.5)	5740 (72.5)	5050 (71.5)	3660 (76)	
55	3650 (65)	4180 (67)	4650 (70)	4280 (69.5)	3540 (72.5)	
60	2850 (62.5)	3320 (64.5)	3720 (67.5)	3480 (67)	3430 (70.5)	³⁰⁰⁰ (76)
65	2140 (60)	2550 (62)	2900 (64.5)	2820 (65)	3320 (68.5)	2890 (72.5)
70	1540 (57.5)	1900 (59)	2210 (62)	2260 (63)	2880 (66)	2790 (70.5)
75	1030 (54.5)	1350 (56)	1620 (59)	1740 (60.5)	2300 (64)	2700 (68)
80			1100 (56)	1300 (58.5)	1800 (61.5)	2240 (65.5)
85				1360 (59)	1750 (63)	
90					1320 (60.5)	
Min. boom angle for indicated length (no load)						
	51.5°	53.5°	53°	56°	56.5°	57.5°
Max. boom length at 0° boom angle (no load)						
	60 ft			60 ft		

NOTE: () Boom angles are in degrees.
#LMI operating code. Refer to LMI manual for instructions.
^{*}This capacity based on maximum boom angle.

A6-829-104323

Boom extension capacity notes:

1. All capacities above the bold line are based on structural strength of boom extension.
2. 26 ft and 45 ft tele extension lengths may be used for single line lifting service.
3. Radii listed are for a fully extended boom with the boom extension erected. For main boom lengths less than fully extended, the rated loads are determined by boom angle. Use only the column which corresponds to the boom extension length and offset for which the machine is configured. For boom angles not shown, use the rating of the next lower boom angle.

Warning: Operation of this machine with heavier loads than the capacities listed is strictly prohibited. Machine tipping with boom extension occurs rapidly and without advance warning.

4. Boom angle is the angle above or below horizontal of the longitudinal axis of the boom base section after lifting rated load.
5. Capacities listed are with outriggers properly extended and vertical jacks set only.
6. When lifting over the main boom nose with 26 ft or 45 ft tele extension erected, the outriggers must be fully extended or 50% extended (14 ft spread).

Load handling

Weight reductions for load handling devices	
26 ft fixed boom extension	lb
* Erected	2750
26 ft - 45 ft telescopic boom extension	
* Erected (retracted) -	3750
* Erected (extended) -	5010
Auxiliary boom nose	lb
	105
Hook blocks and headache balls	lb
35 USt, 3-sheave (14 in sheave)	623 +
35 USt, 3-sheave (12 in sheave)	599 +
35 USt, 4-sheave (CE)	774 +
7.5 USt, overhaul ball	369 +

* Reduction of main boom capacities
+ Refer to rating plate for actual weight

When lifting over swingaway and/or jib combinations, deduct total weight of all load handling devices reeved over main boom nose directly from swingaway or jib capacity.

NOTE: All load handling devices and boom attachments are considered part of the load and suitable allowances **MUST BE MADE** for their combined weights. Weights are for Grove furnished equipment.

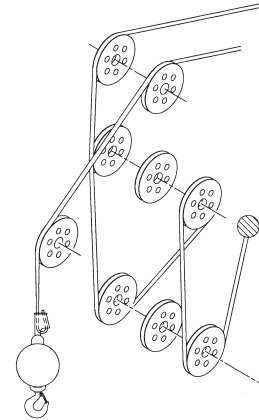

Line pulls and reeving information			
Hoists	Cable specs	Permissible line pulls	Nominal cable length
Main	16 mm (5/8 in) 6 x 37 class EIPS, IWRC Special Flexible Min. Breaking Str. 41,200 lb	11,640 lb	450 ft
Main and auxiliary	16 mm (5/8 in) Flex-X 35 Rotation resistant (non-rotating) Min. breaking Str. 61,200 lb	11,640 lb	450 ft

Hoist performance				
Wire rope layer	Hoist line pulls two-speed hoist		Drum rope capacity (ft)	
	Low available lb ^a	High available lb ^a	Layer	Total
1	11,640	7420	77	77
2	10,480	6680	85	162
3	9530	6070	94	256
4	8730	5570	102	358
5	8060	5140	111	469
6	7490	4770	119	588

^a Max lifting capacity: 6 x 37 class = 11,640 lb
35 x 7 class = 11,640 lb

Working area diagram

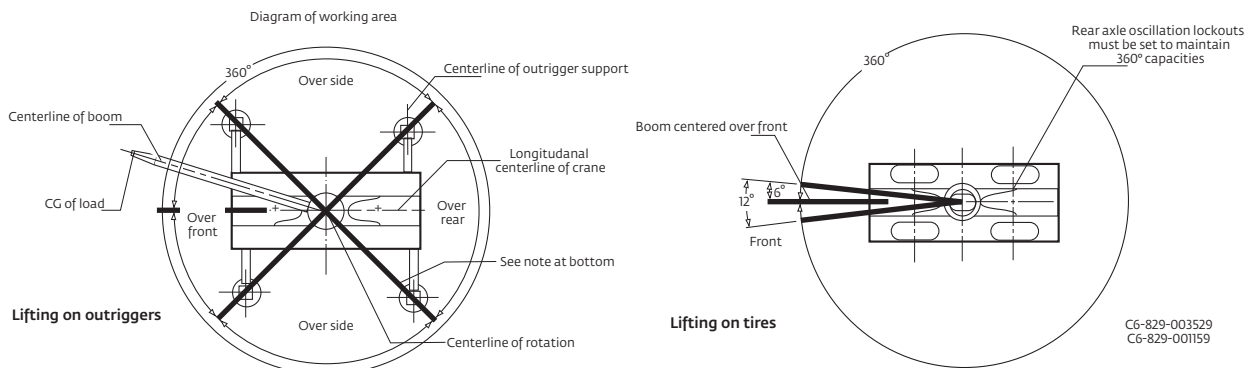

Bold lines determine the limiting position of any load for operation within working areas indicated.

THIS CHART IS ONLY A GUIDE AND SHOULD NOT BE USED TO OPERATE THE CRANE.

The individual crane's load chart, operating instructions and other instructional plates must be read and understood prior to operating the crane.

Manitowoc Cranes

Regional headquarters

Americas

Manitowoc, Wisconsin, USA

Tel: +1 920 684 6621

Fax: +1 920 683 6277

Shady Grove, Pennsylvania, USA

Tel: +1 717 597 8121

Fax: +1 717 597 4062

Europe, Middle East, Africa

Ecully, France

Tel: +33 (0)4 72 18 20 20

Fax: +33 (0)4 72 18 20 00

China

Shanghai, China

Tel: +86 21 6457 0066

Fax: +86 21 6457 4955

Greater Asia-Pacific

Singapore

Tel: +65 6264 1188

Fax: +65 6862 4040

Regional offices

Americas

Brazil

Alphaville

Mexico

Monterrey

Chile

Santiago

Europe, Middle East,

Africa

Czech Republic

Netvorice

France

Baudemont

Cergy

Decines

Germany

Langenfeld

Hungary

Budapest

Italy

Lainate

Netherlands

Breda

Poland

Warsaw

Portugal

Baltar

Russia

Moscow

South Africa

Johannesburg

U.A.E.

Dubai

U.K.

Buckingham

China

Beijing

Chengdu

Guangzhou

Xian

Greater Asia-Pacific

Australia

Brisbane

Melbourne

Sydney

India

Chennai

Delhi

Hyderabad

Pune

Korea

Seoul

Philippines

Makati City

Singapore

Factories

Brazil

Passo Fundo

China

TaiAn

Zhangjiagang

France

Charlieu

Moulins

Germany

Wilhelmshaven

India

Pune

Italy

Niella Tanaro

Portugal

Baltar

Fânzeres

Slovakia

Saris

USA

Manitowoc

Port Washington

Shady Grove

This document is non-contractual. Constant improvement and engineering progress make it necessary that we reserve the right to make specification, equipment, and price changes without notice. Illustrations shown may include optional equipment and accessories and may not include all standard equipment.