



ROUGH TERRAIN CRANE RT 670

DATASHEET - IMPERIAL



RT 670

Features:

- ▶ Rated capacity:
70 ton @ 9 ft working radius
- ▶ Maximum boom length:
111 ft
- ▶ Maximum tip height:
170 ft

WORKS FOR YOU.™

Key

| | |
|-------|---|
| | 3 |
|-------|---|

Dimensions



























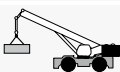















| | |
|------------------------|---|
| Crane dimensions | 4 |
| Crane weights | 5 |

Load charts

| | |
|--|----|
| Range Diagram – Main Boom – Outriggers fully extended (100%) | 6 |
| Load Chart – Main Boom – Outriggers fully extended (100%) | 7 |
| Range Diagram – Main Boom – Outriggers fully retracted (0%) | 8 |
| Load Chart – Main Boom – Outriggers fully retracted (0%) | 9 |
| Range Diagram – Main Boom – 33 ft offsettable jib | 10 |
| Load Chart – Main Boom – 33 ft offsettable jib | 11 |
| Range Diagram – Main Boom – 57 ft offsettable jib | 12 |
| Load Chart – Main Boom – 57 ft offsettable jib | 13 |
| Range Diagram – Main Boom – On tires | 14 |
| Load Chart – Main Boom – On tires | 15 |

Technical description







| | |
|--|--------|
| Boom | 16 |
| Hoist, rope and hook | 16, 17 |
| Superstructure | 17 |
| Cab, controls, operator aids and load limiter / load indicator | 17, 18 |
| Carrier, engine, drive-line and hydraulic system | 18 |
| Vehicle performance | 19 |
| Tires | 19 |

| | | | |
|---|--|---|---|
|  | Counterweight |  | General performance |
|  | Main boom |  | Telescoping mode |
|  | Boom length |  | Boom luffing angle |
|  | Tip height |  | Working radius |
|  | Boom with extension |  | Max. boom length with extension |
|  | Main boom with aux head |  | Distance from the hook to the head sheave pin |
|  | Slewing / Allowable slewing range |  | Slewing locked / Slewing locked at specified position |
|  | Slewing brake |  | Slewing gears |
|  | Outriggers / Lifting on outriggers (100/50/0% extended) |  | Lifting on wheels / Pick & Carry |
|  | Main hoist |  | Auxiliary hoist |
|  | Hoist speed |  | Rope length |
|  | Rope - Standard / Optional |  | Max. line pull |
|  | Rope diameter |  | Tire |
|  | Hook block |  | Controls |
|  | Cab |  | Engine |
|  | Operator aids / Load limiter / Load indicator |  | Steering |
|  | Mechanical transmission |  | Speed |
|  | HYDR Hydraulics |  | Heating / Air conditioning |
|  | Working temperature |  | Gradeability |
|  | Lights |  | Gross vehicle weight |
|  | Crane / Crane in standard configuration |  | Weight on front axle |
|  | Crane without counterweight |  | Weight on rear axle |

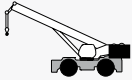
CRANE WEIGHTS

RT 670

Approximate Weights

| | | ↓ GVW | ↑ | ↑ |
|--|------------------------------------|------------|------------|------------|
|  | STD (without hook block) | 85,694 lb | 45,238 lb | 40,456 lb |
| Add / Subtract for main optional equipment | | | | |
|  | 33 ft to 57 ft swing on jib stowed | + 2,170 lb | + 3,580 lb | - 1,410 lb |
|  | Auxiliary boom head | + 125 lb | + 365 lb | - 240 lb |
|  | 2 Auxiliary hoist* | + 584 lb | - 30 lb | + 614 lb |
|  | 5 sheaves, 75T | + 1,040 lb | + 1,971 lb | - 931 lb |
|  | 5 sheaves, 60T | + 1,204 lb | + 2,233 lb | - 1,029 lb |

NOTE: Values are subject to 2% variation

* Weight includes rope

RANGE DIAGRAM - MAIN BOOM

RT 670

Outriggers Fully Extended (100%)

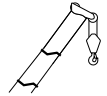

 with hook block:
6 ft 9 in

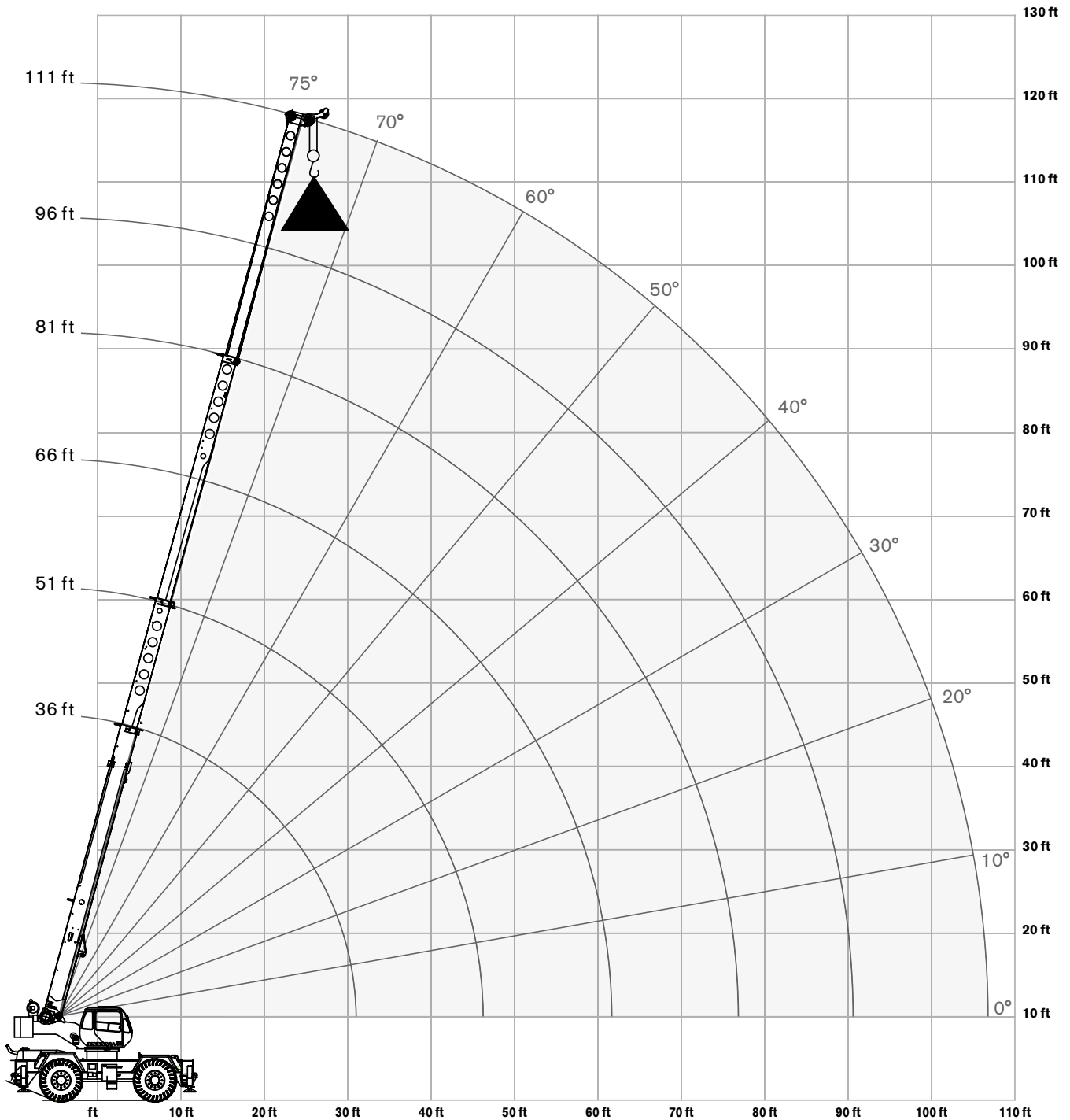

LOAD CHART- MAIN BOOM

RT 670

Outriggers Fully Extended (100%)

 14,200 lbs counterweight

 Outriggers extended 24 ft (100%)

 360 degree rotation

Standard ASME B30.5

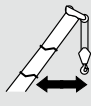
|  | Boom Length | | | | | |  |
|---|-------------|--------|--------|--------|--------|--------|---|
| | 35 ft | 51 ft | 66 ft | 81 ft | 96 ft | 111 ft | |
| ft | lb | lb | lb | lb | lb | lb | ft |
| 9 | 140,000 | | | | | | 9 |
| 10 | 130,000 | 80,000 | | | | | 10 |
| 12 | 106,700 | 80,000 | | | | | 12 |
| 15 | 85,800 | 78,400 | 61,900 | | | | 15 |
| 20 | 62,000 | 63,300 | 54,800 | 46,200 | | | 20 |
| 25 | 47,600 | 48,800 | 49,100 | 40,700 | 35,300 | | 25 |
| 30 | 37,700 | 39,100 | 39,800 | 36,000 | 31,200 | 27,500 | 30 |
| 35 | | 32,200 | 32,900 | 32,300 | 28,000 | 24,800 | 35 |
| 40 | | 26,900 | 27,400 | 27,800 | 25,300 | 22,500 | 40 |
| 45 | | 21,300 | 22,100 | 22,400 | 22,600 | 20,600 | 45 |
| 50 | | | 18,200 | 18,500 | 18,700 | 18,800 | 50 |
| 55 | | | 15,100 | 15,500 | 15,700 | 15,800 | 55 |
| 60 | | | 12,600 | 13,100 | 13,300 | 13,400 | 60 |
| 65 | | | | 11,200 | 11,400 | 11,500 | 65 |
| 70 | | | | 9,500 | 9,800 | 9,900 | 70 |
| 75 | | | | 8,100 | 8,400 | 8,600 | 75 |
| 80 | | | | | 7,300 | 7,400 | 80 |
| 85 | | | | | 6,200 | 6,400 | 85 |
| 90 | | | | | 5,300 | 5,600 | 90 |
| 95 | | | | | | 4,800 | 95 |
| 100 | | | | | | 4,100 | 100 |
| 105 | | | | | | 3,500 | 105 |

Notes to lifting capacity

Lifting capacities do not exceed 85% of tipping load. Weight of hook blocks and slings is part of the load, and is to be deducted from the capacity ratings. Consult operation manual for further details.

Note: Data published herein is intended as a guide only and shall not be construed to warrant applicability for lifting purposes. Crane operation is subject to the computer charts and operation manual both supplied with the crane.

RANGE DIAGRAM - MAIN BOOM

RT 670

Outriggers Fully Retracted (0%)

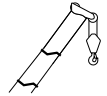

 with hook block:
6 ft 9 in

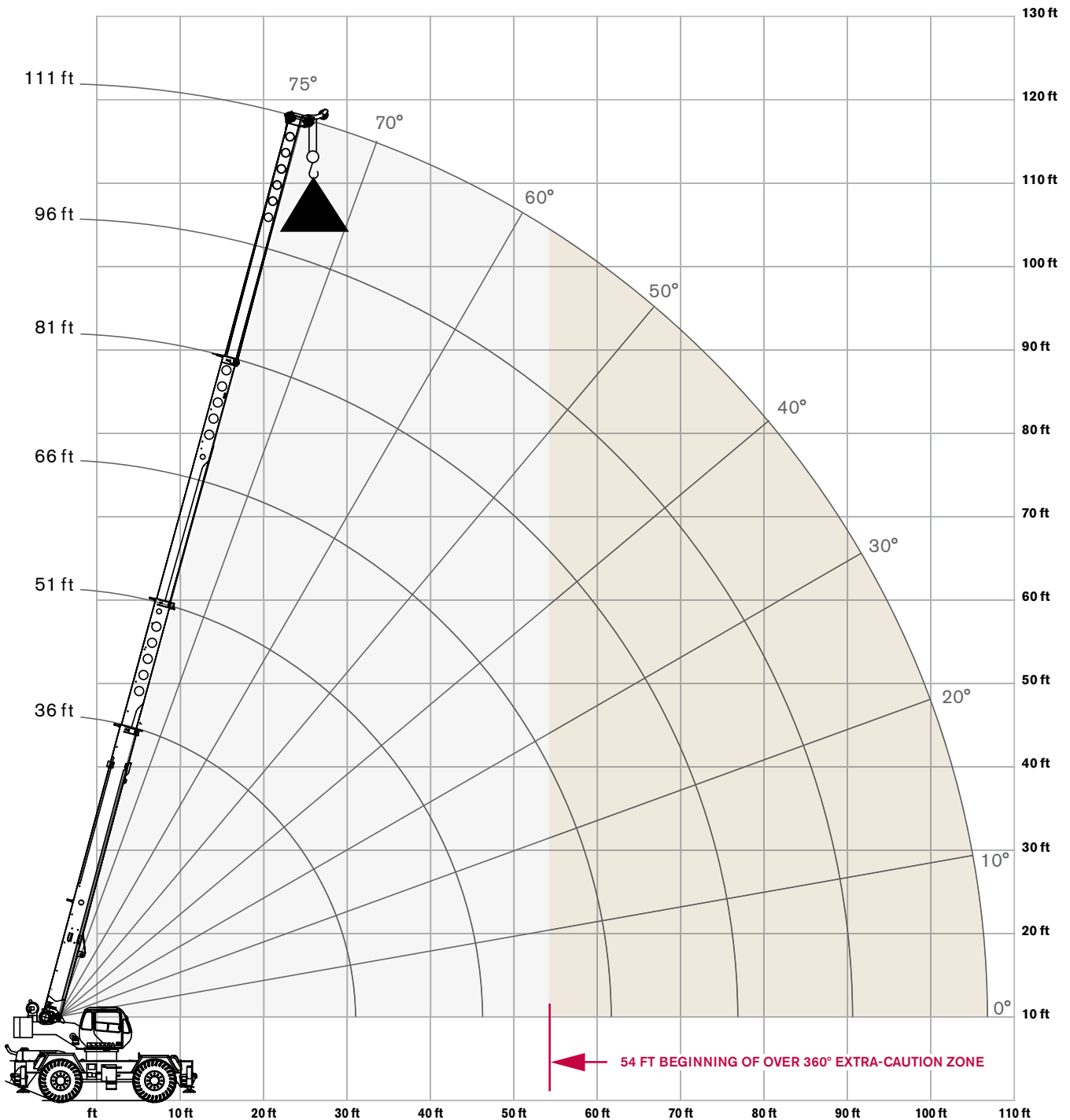



LOAD CHART- MAIN BOOM

RT 670

Outriggers Fully Retracted (0%)

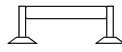
 14,200 lbs counterweight

 Outriggers retracted 9 ft 10 in (0%)

 360 degree rotation

Standard ASME B30.5

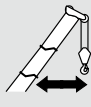
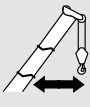
|  | Boom Length | | | | | |  |
|---|-------------|--------|--------|--------|--------|--------|---|
| | 35 ft | 51 ft | 66 ft | 81 ft | 96 ft | 111 ft | |
| ft | lb | lb | lb | lb | lb | lb | ft |
| 10 | 73,600 | 74,800 | | | | | 10 |
| 12 | 51,600 | 52,600 | | | | | 12 |
| 15 | 34,200 | 35,200 | 35,700 | | | | 15 |
| 20 | 20,000 | 21,300 | 21,700 | 22,000 | | | 20 |
| 25 | 12,700 | 14,000 | 14,500 | 14,800 | 14,900 | | 25 |
| 30 | 8,100 | 9,500 | 10,100 | 10,400 | 10,600 | 10,700 | 30 |
| 35 | | 6,500 | 7,100 | 7,500 | 7,600 | 7,700 | 35 |
| 40 | | 4,300 | 4,900 | 5,300 | 5,500 | 5,600 | 40 |
| 45 | | 2,500 | 3,300 | 3,700 | 3,900 | 4,000 | 45 |
| 50 | | | | 2,400 | 2,600 | 2,800 | 50 |

Notes to lifting capacity

Lifting capacities do not exceed 85% of tipping load. Weight of hook blocks and slings is part of the load, and is to be deducted from the capacity ratings. Consult operation manual for further details.

Note: Data published herein is intended as a guide only and shall not be construed to warrant applicability for lifting purposes. Crane operation is subject to the computer charts and operation manual both supplied with the crane.

RANGE DIAGRAM - MAIN BOOM

RT 670

With Jib, 33 ft offset

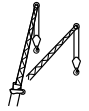

with hook block:
6 ft 9 in

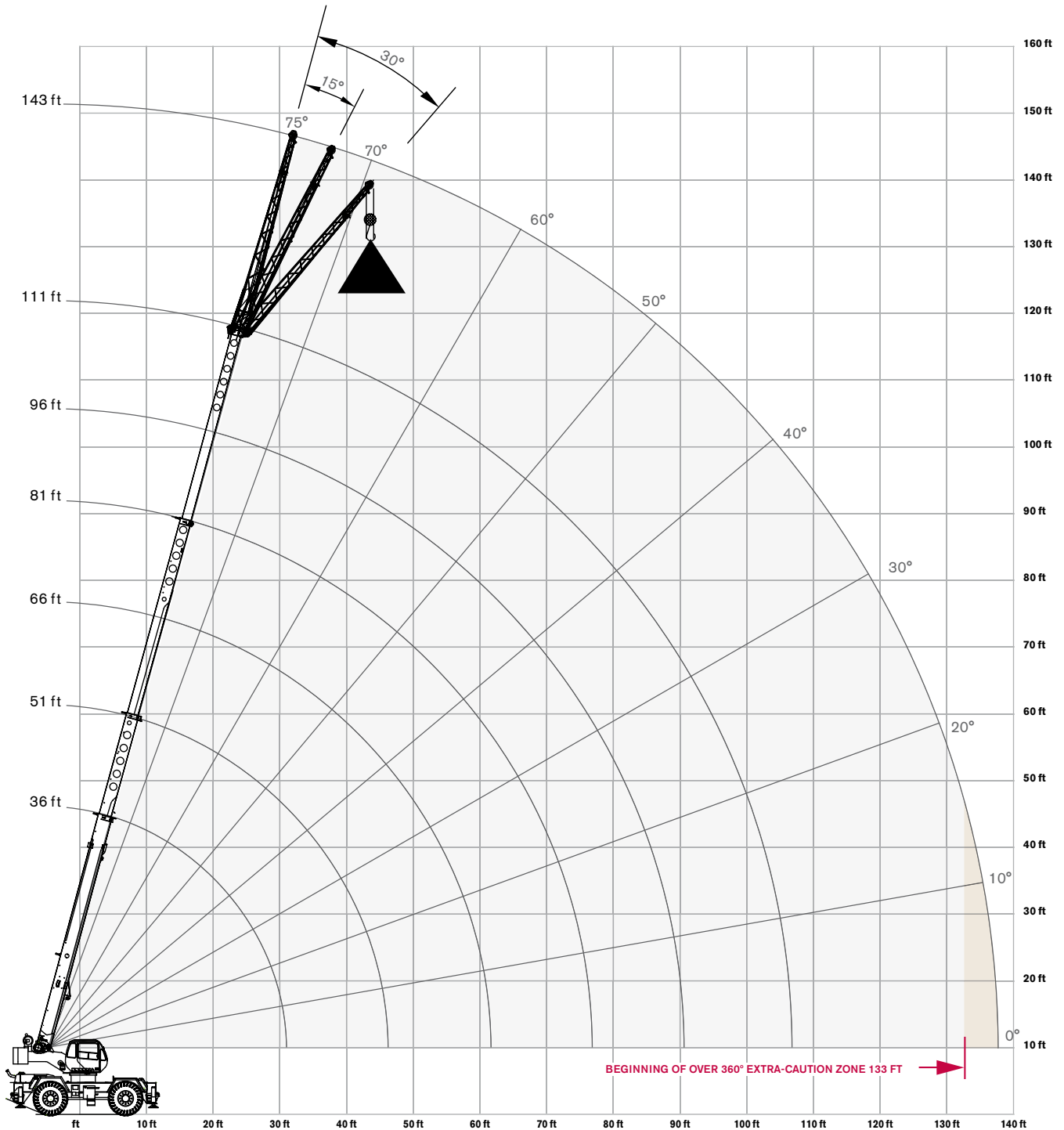



LOAD CHART- MAIN BOOM

RT 670



With Jib, 33 ft offset

 14,200 lbs counterweight

 Outriggers extended 24 ft (100%)

 360 degree rotation

Standard ASME B30.5

| 33 ft Offsettable Jib | | | | | |
|---|--------|---|-------|---|-------|
| 0° Offset | | 15° Offset | | 30° Offset | |
|  Radius (ft) | lbs |  Radius (ft) | lbs |  Radius (ft) | lbs |
| 41 | 12,500 | 49 | 8,400 | 55 | 6,500 |
| 47 | 11,800 | 54 | 8,100 | 60 | 6,300 |
| 52 | 11,200 | 59 | 7,700 | 64 | 6,200 |
| 59 | 10,300 | 66 | 7,300 | 71 | 5,900 |
| 66 | 9,500 | 72 | 7,000 | 77 | 5,800 |
| 72 | 8,800 | 79 | 6,700 | 84 | 5,600 |
| 79 | 8,100 | 85 | 6,400 | 89 | 5,400 |
| 87 | 6,700 | 92 | 6,100 | 96 | 5,200 |
| 94 | 5,600 | 99 | 5,100 | 103 | 4,900 |
| 101 | 4,600 | 106 | 4,300 | 109 | 4,100 |
| 107 | 3,800 | 112 | 3,500 | 114 | 3,500 |
| 114 | 3,000 | 120 | 2,800 | 120 | 2,800 |
| 122 | 2,200 | 125 | 2,100 | 126 | 2,100 |
| 129 | 1,700 | 132 | 1,600 | | |
| 135 | 1,200 | 137 | 1,200 | | |

Notes to lifting capacity

Lifting capacities do not exceed 85% of tipping load. Weight of hook blocks and slings is part of the load, and is to be deducted from the capacity ratings. Consult operation manual for further details.

Note: Data published herein is intended as a guide only and shall not be construed to warrant applicability for lifting purposes. Crane operation is subject to the computer charts and operation manual both supplied with the crane.

RANGE DIAGRAM - MAIN BOOM

RT 670

With Jib, 57 ft offset

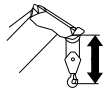

 with hook block:
6 ft 9 in

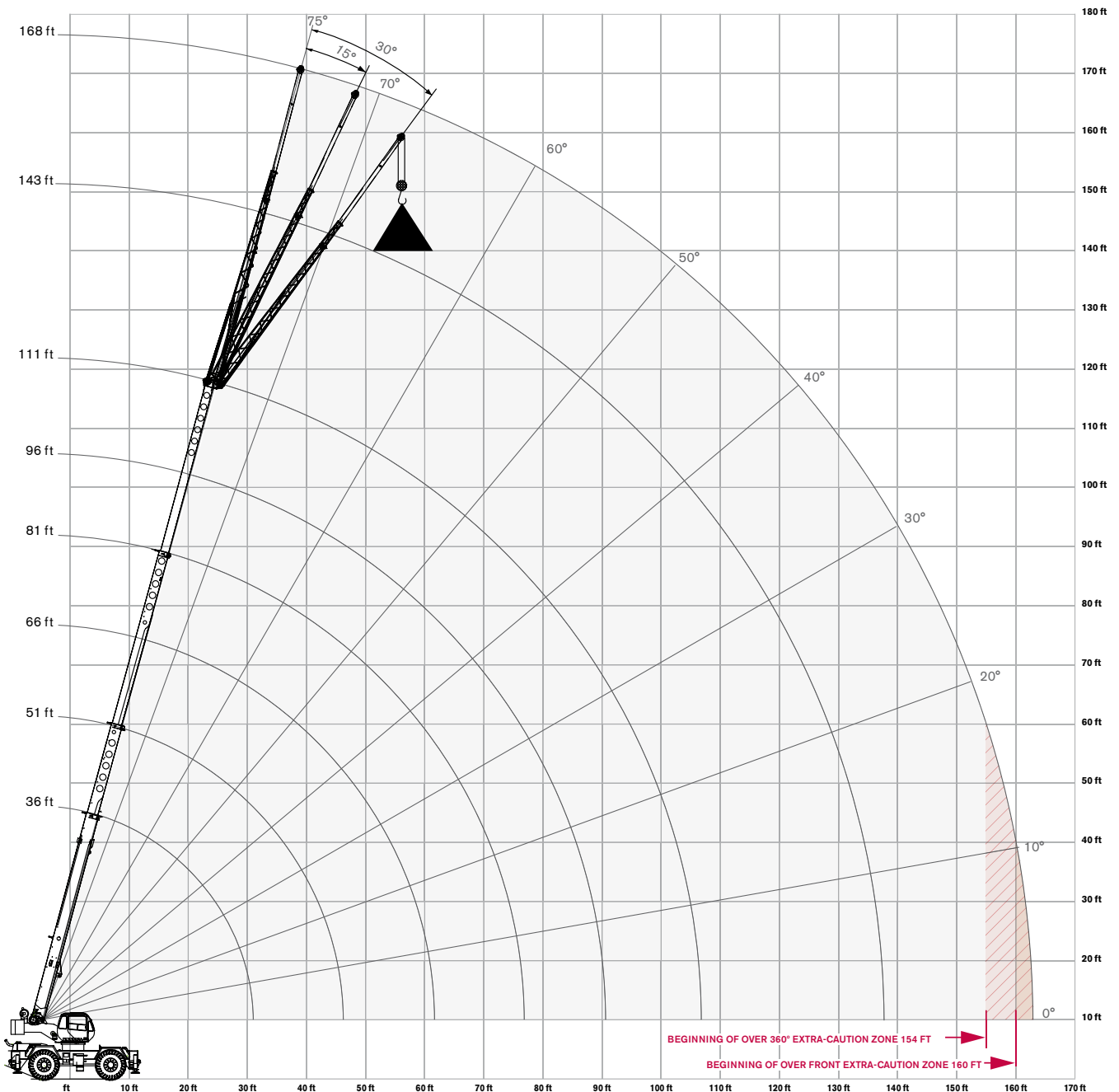



LOAD CHART- MAIN BOOM

RT 670



With Jib, 57 ft offset

 14,200 lbs counterweight

 Outriggers extended 24 ft (100%)

 360 degree rotation

Standard ASME B30.5

| 57 ft Offsettable Jib | | | | | |
|---|-------|---|-------|---|-------|
| 0° Offset | | 15° Offset | | 30° Offset | |
|  Radius (ft) | lbs |  Radius (ft) | lbs |  Radius (ft) | lbs |
| 52 | 6,500 | 64 | 4,500 | 74 | 3,300 |
| 58 | 6,100 | 70 | 4,300 | 80 | 3,200 |
| 64 | 5,800 | 76 | 4,100 | 85 | 3,100 |
| 73 | 5,500 | 83 | 3,800 | 92 | 3,000 |
| 81 | 5,100 | 91 | 3,600 | 99 | 2,900 |
| 89 | 4,700 | 98 | 3,400 | 106 | 2,800 |
| 96 | 4,400 | 105 | 3,300 | 112 | 2,700 |
| 105 | 4,000 | 113 | 3,100 | 119 | 2,600 |
| 114 | 3,700 | 121 | 2,900 | 126 | 2,600 |
| 122 | 3,400 | 128 | 2,800 | 132 | 2,500 |
| 129 | 2,900 | 135 | 2,700 | 138 | 2,500 |
| 137 | 2,300 | 142 | 2,100 | 144 | 2,100 |
| 145 | 1,700 | 149 | 1,600 | 149 | 1,600 |
| 153 | 1,200 | 155 | 1,100 | | |
| 159 | 900 | 160 | 800 | | |

Notes to lifting capacity

Lifting capacities do not exceed 85% of tipping load. Weight of hook blocks and slings is part of the load, and is to be deducted from the capacity ratings. Consult operation manual for further details.

Note: Data published herein is intended as a guide only and shall not be construed to warrant applicability for lifting purposes. Crane operation is subject to the computer charts and operation manual both supplied with the crane.

RANGE DIAGRAM - MAIN BOOM

RT 670

On Tires

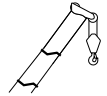

 with hook block:
6 ft 9 in

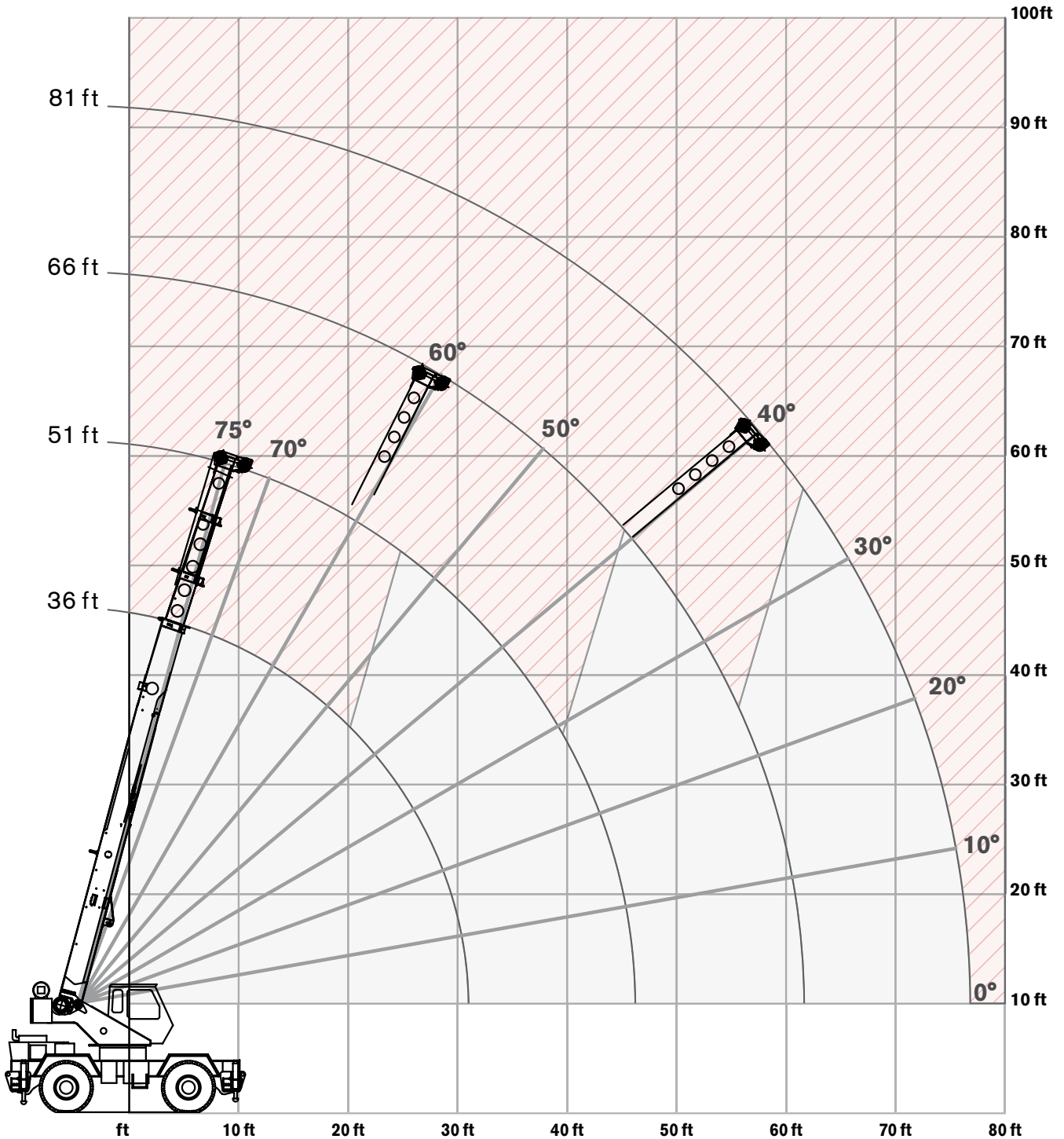



LOAD CHART- MAIN BOOM

RT 670

On Tires

 14,200 lbs counterweight

 360 degree rotation

 On tires
29.5 X 25-28PR

Standard ASME
B30.5









| Boom | | Travel Speed Boom straight over front | | |
|--------|--------|--|--------|---------|
| Radius | Length | 0 mph | Creep | 2.5 mph |
| ft | ft | lb | lb | lb |
| 10 | 36 | 87,500 | 68,700 | 51,800 |
| 12 | 36 | 77,200 | 60,400 | 45,300 |
| 15 | 36 | 61,300 | 50,700 | 37,600 |
| 20 | 36 | 37,200 | 37,200 | 28,700 |
| 25 | 51 | 22,500 | 22,500 | 22,500 |
| 30 | 51 | 15,600 | 15,600 | 15,600 |
| 35 | 51 | 12,600 | 12,600 | 12,600 |
| 40 | 51 | 10,100 | 10,100 | 10,100 |
| 45 | 66 | 8,000 | 8,000 | 8,000 |
| 50 | 66 | 6,400 | 6,400 | 6,400 |
| 55 | 66 | 5,100 | 5,100 | 5,100 |
| 60 | 81 | 4,100 | 4,100 | 4,100 |
| 65 | 81 | 3,300 | 3,300 | 3,300 |
| 75 | 81 | 2,600 | 2,600 | 2,600 |

Notes to lifting capacity







Lifting capacities do not exceed 75% of tipping load. Weight of hook blocks and slings is part of the load, and is to be deducted from the capacity ratings. Consult operation manual for further details.





Note: Data published herein is intended as a guide only and shall not be construed to warrant applicability for lifting purposes. Crane operation is subject to the computer charts and operation manual both supplied with the crane.

Boom



| Standard configuration: | |
|---|--|
|  | 4 sections hydraulic actuated boom |
|  | Full power mechanically synchronized |
|  | Min. / Max. 36 ft / 111 ft |
|  | Boom elevation angle range (min. / max.) -4° / 76° |
| Optional configuration: | |
|  | Single sheave |
|  | One section, side stowable, with pull out insert 33 ft / 57 ft Angular offsets 0, 15 and 30 degrees |
|  | With one section jib (max.) 146 ft |
|  | With two section jib (max.) 170 ft |

Hoist, Rope and Hook



| Standard configuration: | |
|---|--|
|  | Grooved drum Storage capacity 561 ft |
|  | Two speed ratios Without load in 5th layer (low range / high range) 269 ft/min / 431 ft/min Without load in 1st layer (low range / high range) 187 ft/min / 300 ft/min |
|  | 6 x 19 IWRC XIPS, right regular lay, preformed |
|  | 3/4 in |
|  | 600 ft |
|  | Max. line pull; 1st layer low-range 18,450 lb Max. line pull permissible 13,800 lb |

| Optional configuration: | | |
|---|--|--|
|  | 5 sheaves 5 sheaves | 60 ton 75 ton |
|  | Grooved drum Storage capacity | 591 ft |
|  | Without load in 5th layer (low range / high range) Without load in 1st layer (low range / high range) | 269 ft/min / 431 ft/min 187 ft/min / 300 ft/min |
|  | Rotation resistant compacted strand 34X7 | |
|  | | 3/4 in |
|  | | 600 ft |
|  | Minimum breaking strength Permissible line pull | 69,000 lbs 13,800 lbs |

Superstructure

| Standard configuration: | | |
|---|---|-----------------|
|  | Non stop Maximum rotation speed without load | 360° 1.9 rpm |
|  | Hydraulic motor Planetary reducer 360° house lock | |
|  | Manually actuated by foot pedal | |

Cab, Controls, Operator aids and Load limiter / Load indicator

| Standard configuration: | | |
|---|--|--|
|  | Sliding door Hinged, tinted all glass skylight Six way adjustable seat | |
|  | Armrest mounted dual axis electro-proportional joysticks Steering wheel column with gear selector on the left and directional light selector on the right Dashboard mounted switches for outrigger operation | |
|  | Graphic interface for load indicator | |

Optional configuration:



Hydraulic powered air conditioner
 Hydraulic powered heater
 Work lights
 Rotating beacon

Carrier, Engine, Drive-line and Hydraulic system

Standard configuration:



Hydraulic, independent extension:
 Diameter of outrigger pads
 Area of outrigger pads

24 in
 452 in²



Cummins QSB6.7 6 cylinders
 Rated power
 Maximum gross torque
 Intake: turbocharger with intercooler
 Fuel type
 Fuel tank capacity

215 hp @ 2,500 rpm
 655 ft·lb @ 1,500 rpm
 Diesel
 50 gallons



6 x 6 powershift transmission with torque converter
 Selectable 4WD (Four-Wheel Drive)
 Rigid mounted front axle
 Oscillating rear axle
 Differential lock on front and rear axles
 Rear axle oscillation lock - manual or automatic actuation
 Air-over-hydraulic disc brakes
 Front axle parking brake
 Hydraulic oil cooler



Hydraulic power steering
 Front wheel steering
 Four wheel steering concentric
 Four wheel steering crab



Hydraulic Pumps:

Tandem pumps:

Boom lift / Telescope
 Power steering / Outriggers and swing

37.3 gal/min @ 3,500 psi
 18.7 gal/min @ 3,500 psi

Single pump:

Main and auxiliary hoist pump

52.7gal/min @ 4,500 psi

Hydraulic oil reservoir capacity
 Hydraulic oil suction filter
 Hydraulic oil return filter

116 gallons
 250 microns
 5 microns

Vehicle performance

| Standard configuration: | | |
|---|--|----------------|
|  | Max. in 1 st gear Max. in 6 th gear | 127.6% 5.9% |
|  | Max. (6 th gear) | 23.4 mph |

Tires

| Standard configuration: | | |
|---|----------------------------------|----------------|
|  | Wide tread - Earth mover pattern | 29.5 x 25-28PR |

www.terexcranes.com

Effective Date: September 2010. Product specifications and prices are subject to change without notice or obligation. The photographs and/or drawings in this document are for illustrative purposes only. Refer to the appropriate Operator's Manual for instructions on the proper use of this equipment. Failure to follow the appropriate Operator's Manual when using our equipment or to otherwise act irresponsibly may result in serious injury or death. The only warranty applicable to our equipment is the standard written warranty applicable to the particular product and sale and Terex makes no other warranty, express or implied. Products and services listed may be trademarks, service marks or trade-names of Terex Corporation and/or its subsidiaries in the USA and other countries. All rights are reserved. Terex® is a registered trademark of Terex Corporation in the USA and many other countries. Copyright 2010 Terex Corporation..

Terex Cranes, Global Marketing, Dinglerstraße 24, 66482 Zweibrücken, Germany
Tel. +49 (0) 6332 830, Email: info.cranes@terex.com, www.terexcranes.com

Brochure Reference: TC-DS-I-E-RT 670-09/10



WORKS FOR YOU.™