

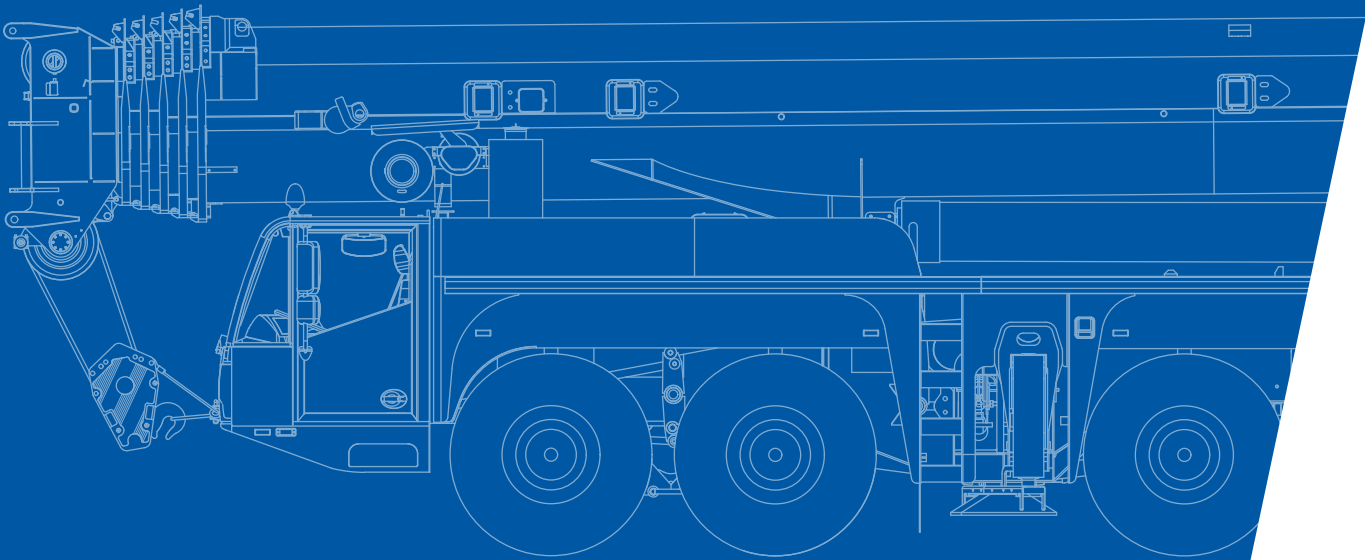





AC 350-6



**All Terrain Crane
400 USt Capacity class**

DEMAG[®]
BY TEREX

		Page:
Specifications		4
	HA Main boom	13
	HA-SL Main boom with SL	14
	HAV Folding swing-away jib	22
	HAV-SL Folding swing-away jib with SL	25
	LF Light fixed jib	26
	LF-A Light fixed jib with offset section	27
	SF Strong fixed jib	29
	SF-A Strong fixed jib with offset section	30
	SF-SL Strong fixed jib with SL	34
	SF-A-SL Strong fixed jib with offset section and SL	34
	(S)WIHI (Strong) Luffing fly jib (optimized for lifting capacity)	36
	WIHI-A Luffing fly jib (optimized for lifting capacity) with offset section	37
	(S)WIHI-SL (Strong) Luffing fly jib (optimized for lifting capacity) with SL	47
	WIHI-A-SL Luffing fly jib (optimized for lifting capacity) with offset section and SL	47
	MS Runner	51
	MS-A Runner with offset section	52
	MS-SL Runner with SL	53
	MS-A-SL Runner with offset section and SL	53
Technical description		54

	Counterweight		Slewing
	Lifting capacities on outriggers · 360°		Boom telescoping
	Radius		Boom elevation
	Main boom		Angle of extension
	Folding swing-away jib		Workings speeds
	Fixed fly jib		Max. line pull
	Luffing fly jib		Rope diameter
	Runner		Rope length
	Adapter		Hook block (capacity-sheaves-rope diameter)
	Max. axle loads		Number of lines
	Mechanism		Possible load of hook block
	Tires		Weight of hook block
	Hook block		Distance head sheave axle – hook ground
	Hoist		Number of sheaves in boom head
	Dolly		Supporting force
	Superlift		Length of stroke (support cylinders)
	Travel speed		Front outrigger
	Gradeability – road		Rear outrigger
	Gradeability – off road		

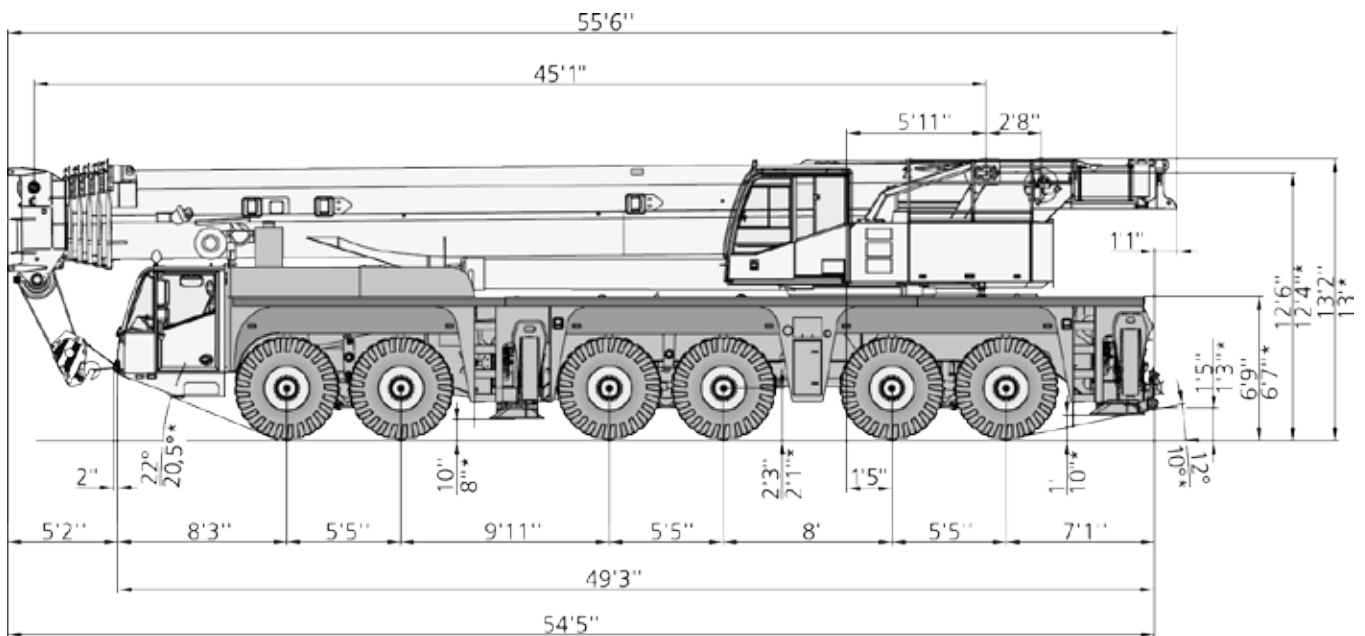

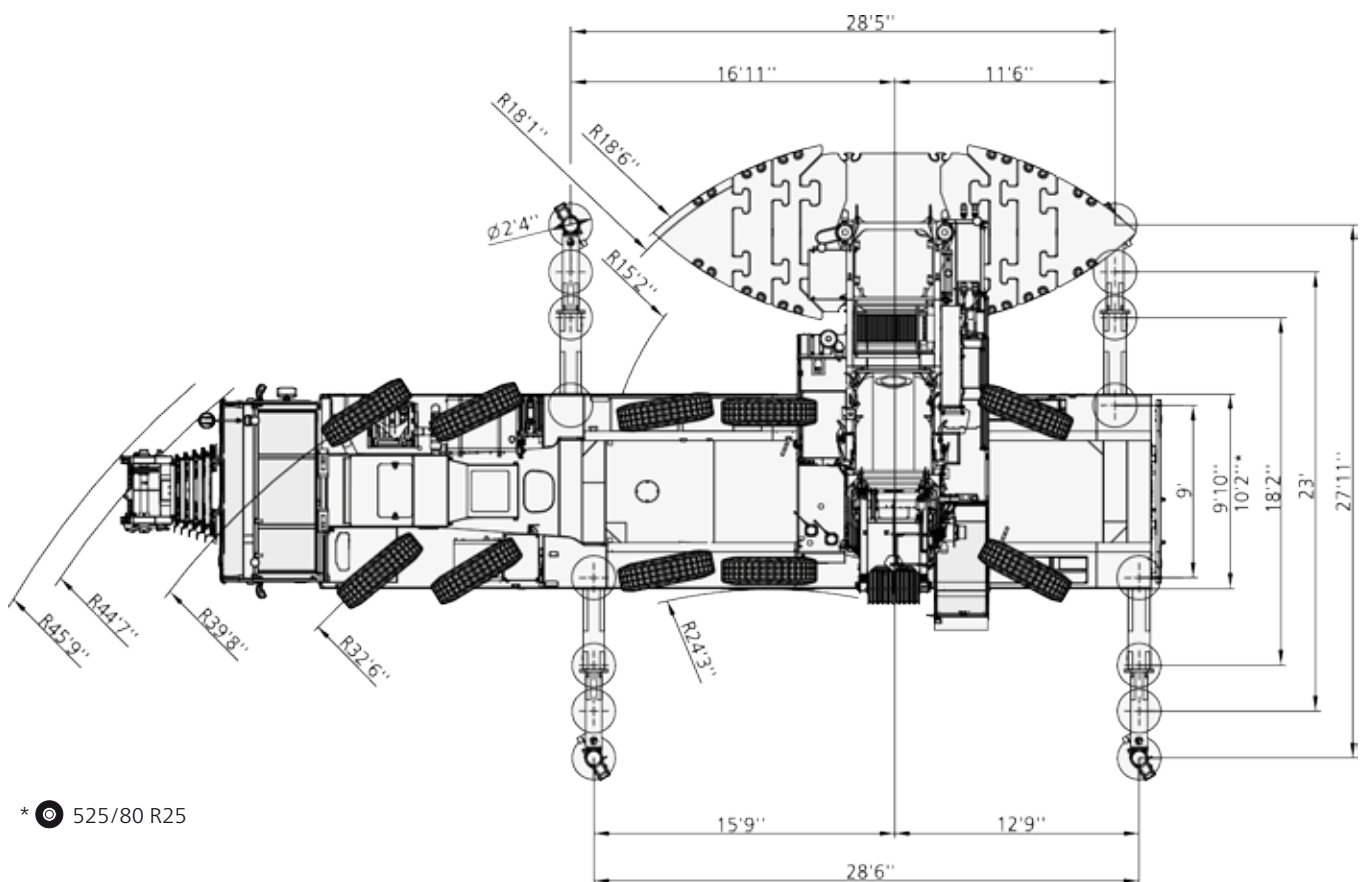

⊙ 445/95 R25 / 525/80 R25

* ⊙ 385/95 R25

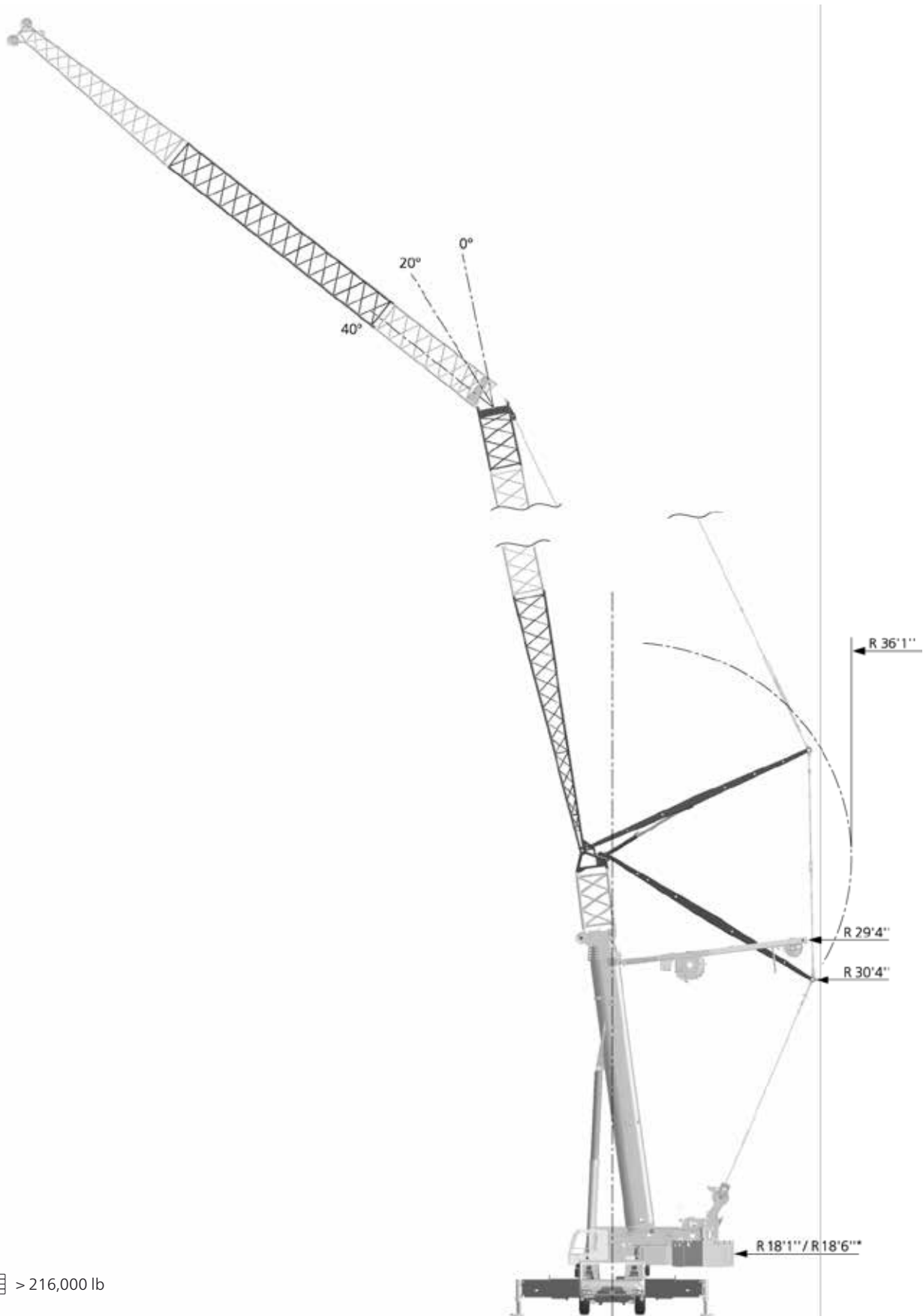

*  525/80 R25



*  > 216,000 lb

Dimensions

AC 350-6

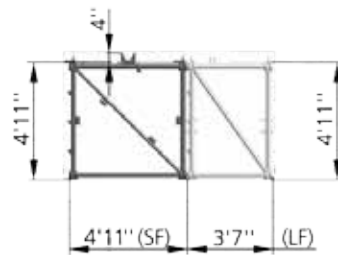
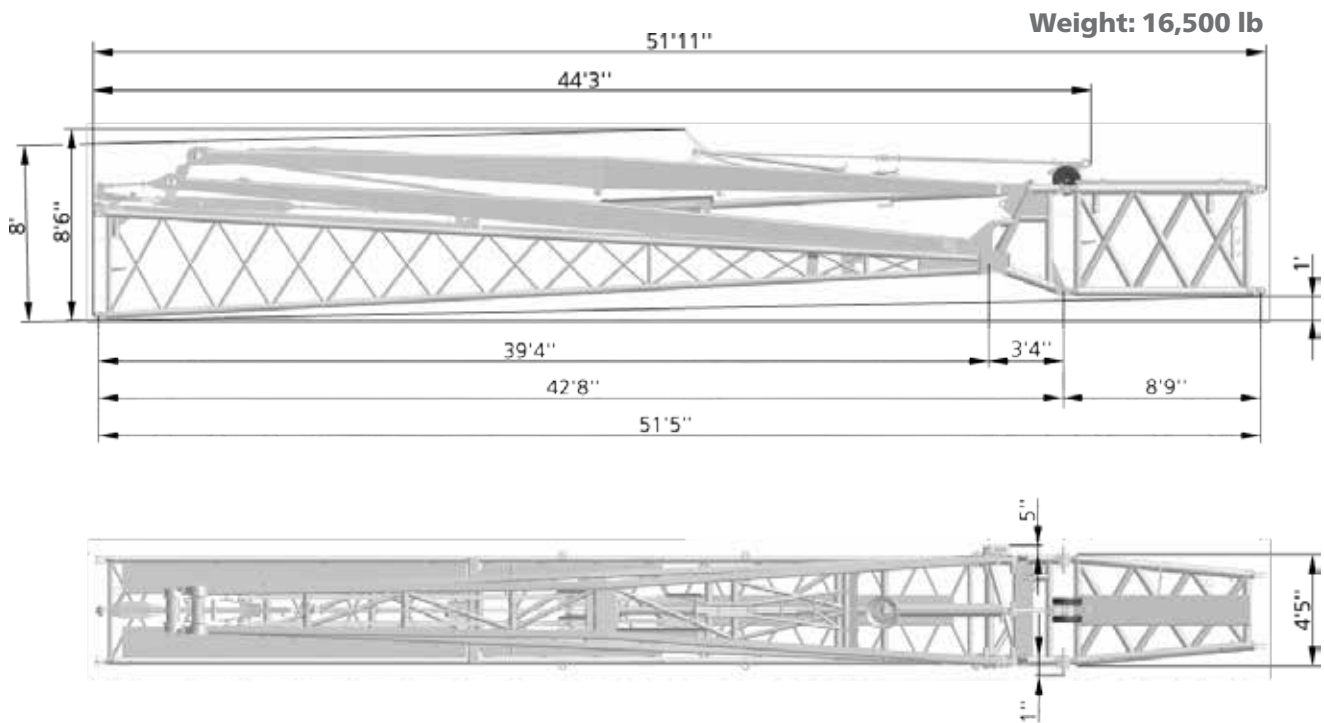



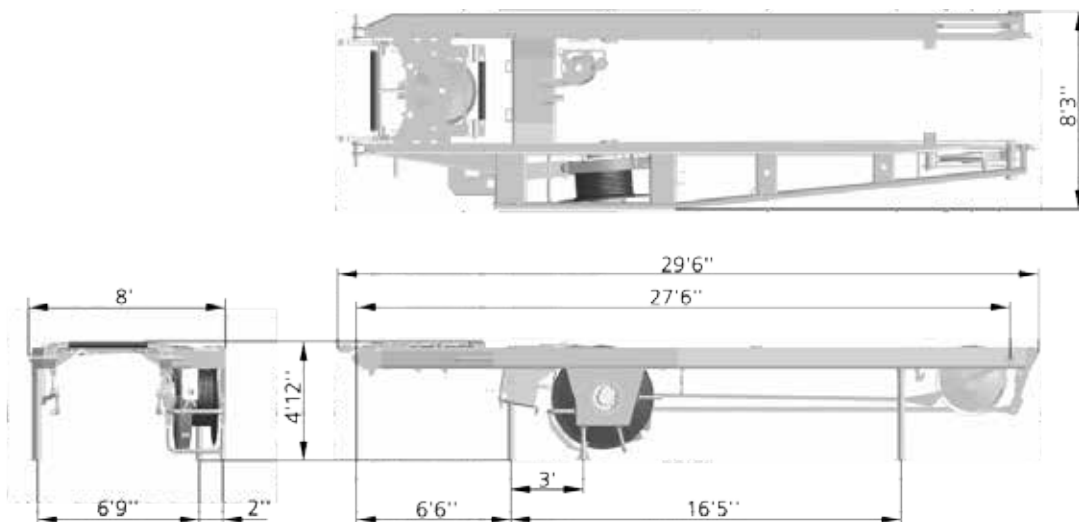













Weight: 12,800 lb





Specifications

AC 350-6





										
< 26,500 lb	On request and technical verification									X
26,500 lb	158,800 lb	12 x 8 x 10	525/80R25	40-1-23	-	X	-	-	-	-











	1 Highway > 28 mph Axles 4-6 rigid		4* Off-wall No tail swing
	2 City < 28 mph Axles 5+6 with speed dependent steering		5* Crab steer mode All axles in the same direction
	3* Minimum turning radius < 3 mph Axles 5+6 steered automatically		6* Manually steered Axles 5+6 manually steerable





* must be activated

		249,100 lb	284,400 lb	52.8 mph ¹⁾
	19.3"	22.0"		

¹⁾ Depending on tire type, size and country specific legislation

		385 / 95 R25 14.00 R25	445 / 95 R25 16.00 R25	525 / 80 R25 20.50 R25
	49 %	44 %	44 %	
	77 %	67 %	67 %	

				
	381 ft/min	25,600 lbf	0.91"	1247 ft
	381 ft/min	25,600 lbf	0.91"	1591 ft
	1,0 min ⁻¹			
	440 s (44.9-210 ft)			
	60 s (0°-83°)			

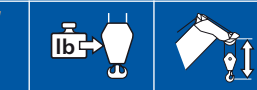
					
1	25,400	12-0-24	6	1,100 lb	6.6 ft
2	50,500	40-1-23	6	1,650 lb	8.9 ft
3	75,400	40-1-23	6	1,650 lb	8.9 ft
4	100,100	80-3-23	6	2,320 lb	9.8 ft
5	124,400	80-3-23	6	2,320 lb	9.8 ft
6	148,600	80-3-23	6	2,320 lb	9.8 ft
7	172,400	80-3-23	6	2,320 lb	9.8 ft
8	196,000	125-5-23	6	2,650 lb	9.8 ft
9	219,400	125-5-23	6	2,650 lb	9.8 ft
10	242,800	125-5-23	6	2,650 lb	9.8 ft
11	265,700	125-5-23	6	2,650 lb	9.8 ft
12	288,400	160-7-23	6	3,750 lb	9.8 ft
13	310,900	160-7-23	6 + 4	3,750 lb	9.8 ft
14	333,200	160-7-23	6 + 4	3,750 lb	9.8 ft
15	355,200	200-9-23	6 + 4	3,750 lb	9.8 ft
16	377,000	200-9-23	6 + 4	4,410 lb	9.8 ft
17	398,700	200-9-23	6 + 4	4,410 lb	9.8 ft
18	420,000	200-9-23	6 + 4	4,410 lb	9.8 ft
19	441,000	200-9-23	6 + 4	4,410 lb	9.8 ft

Counterweight

AC 350-6

Parts

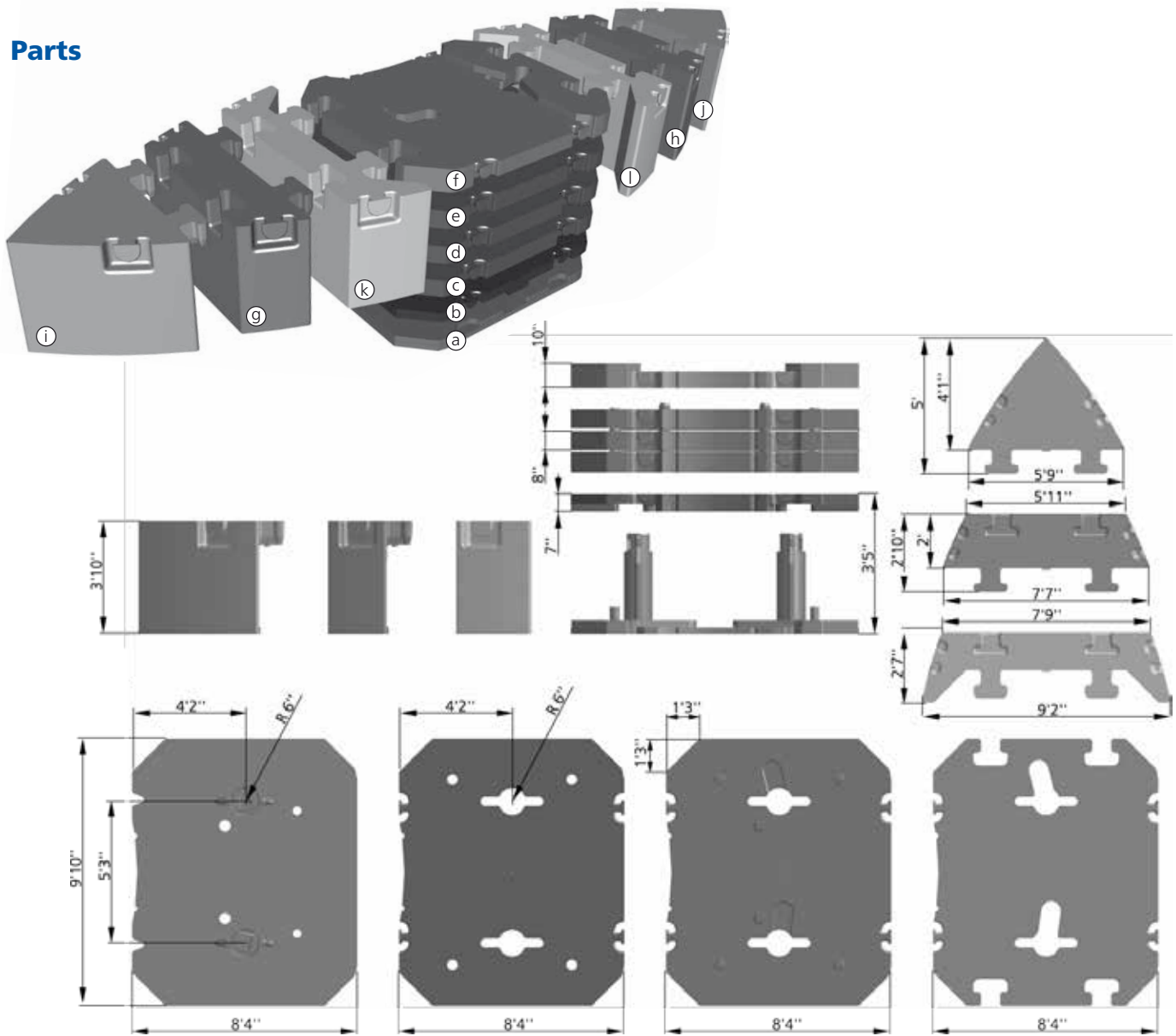

Configurations

	Ⓐ 17.6 kip	Ⓑ 14.3 kip	Ⓒ 22.3 kip	Ⓓ 22.3 kip	Ⓔ 22.3 kip	Ⓕ 20.9 kip	Ⓖ 22.9 kip	Ⓗ 22.9 kip	Ⓘ 22.9 kip	Ⓢ 22.9 kip	Ⓚ 22.9 kip	Ⓛ 22.9 kip
17,600 lb	X											
32,000 lb	X	X										
39,900 lb	X		X									
54,200 lb	X	X	X									
76,500 lb	X	X	X	X								
98,800 lb	X	X	X	X	X							
119,700 lb	X	X	X	X	X	X						
165,600 lb	X	X	X	X	X	X					X	X
165,600 lb	X	X	X	X	X	X	X	X				
211,500 lb	X	X	X	X	X	X	X	X	X	X		
211,500 lb	X	X	X	X	X	X	X	X			X	X
257,300 lb	X	X	X	X	X	X	X	X	X	X	X	X

Boom Combinations

AC 350-6

HAV

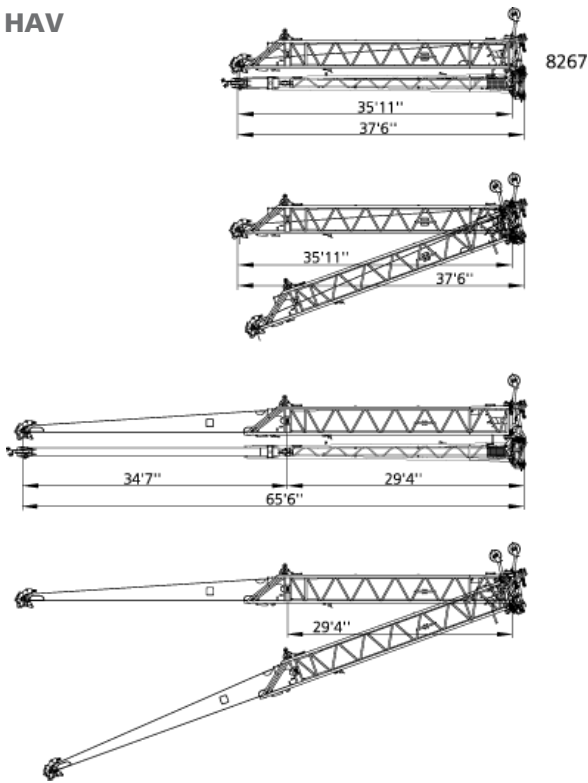

LF

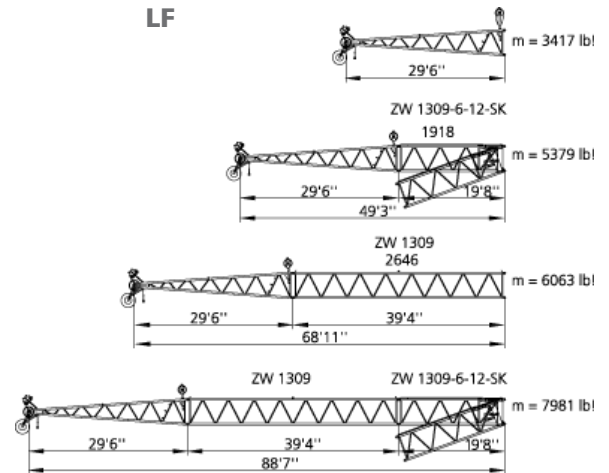

SF

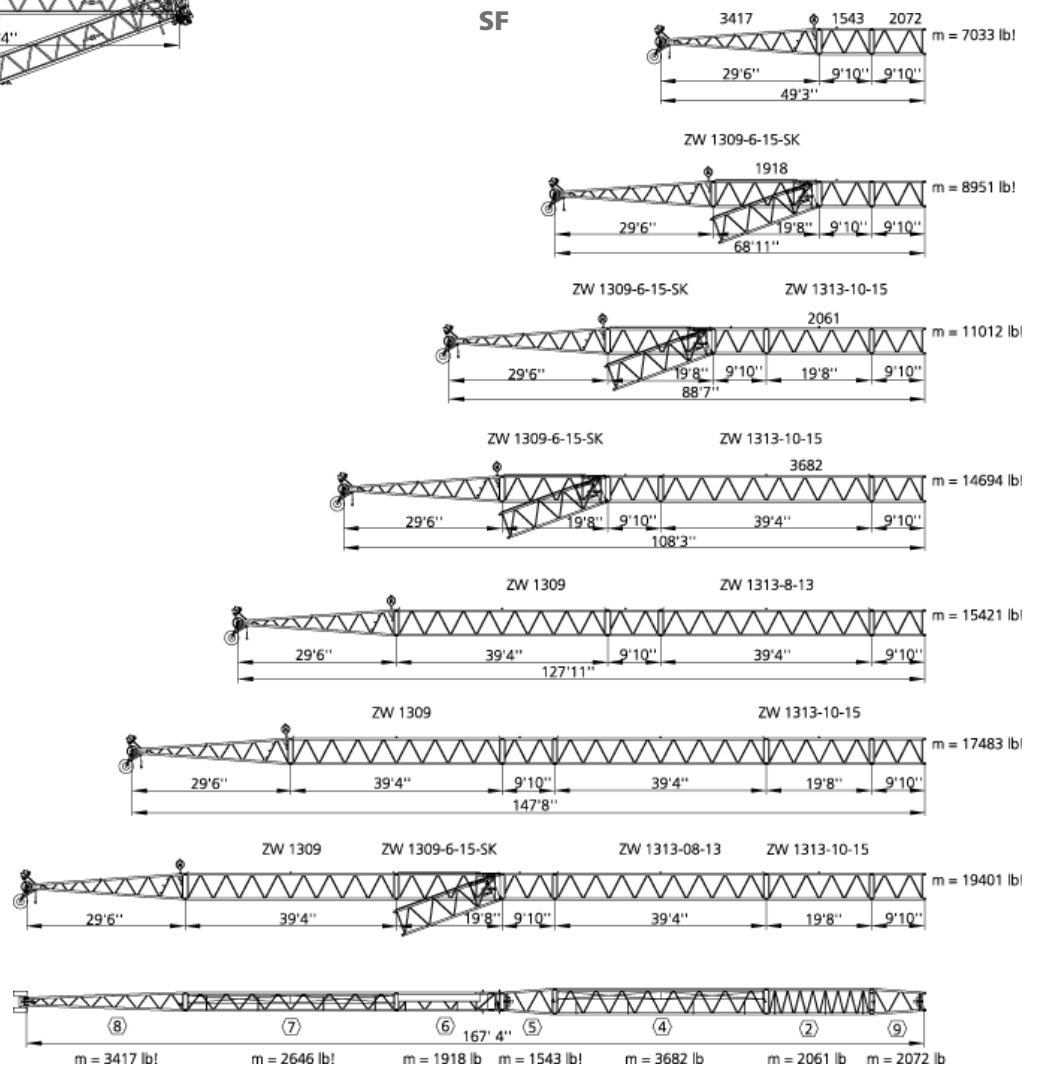

WIHI

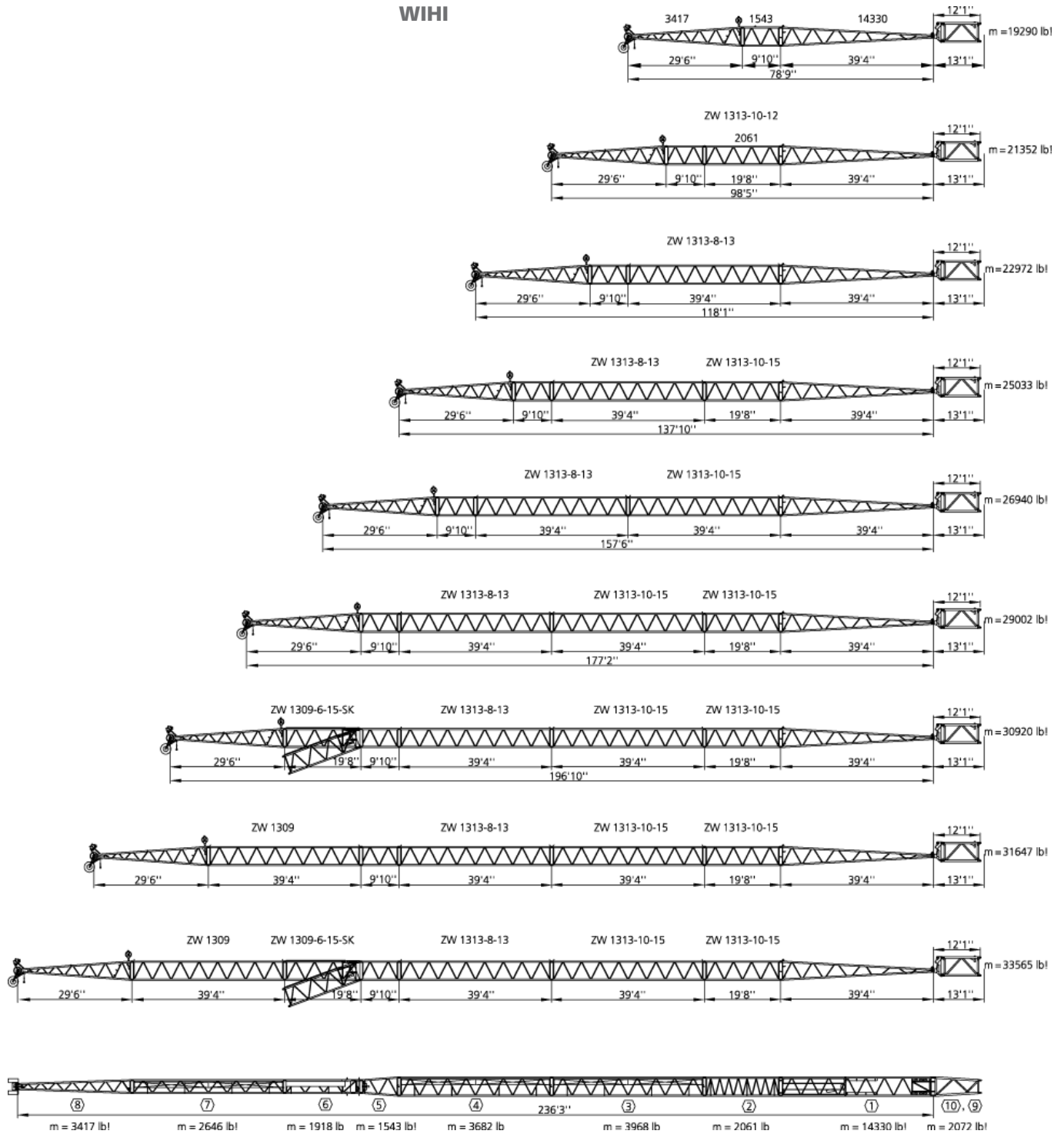

Boom Combinations

AC 350-6

TWIHI

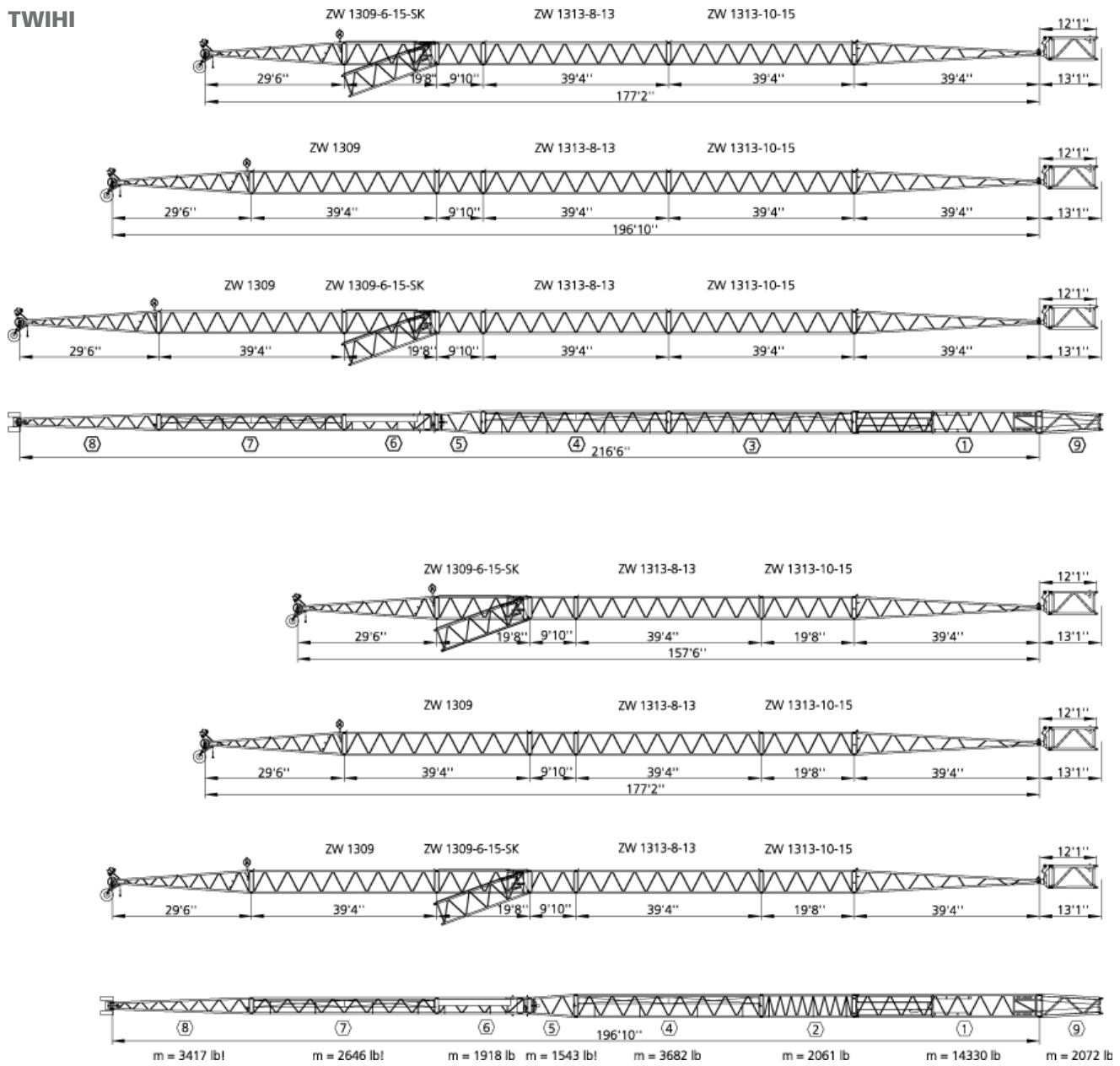

SWIHI

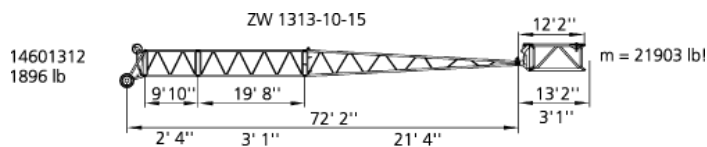

MS

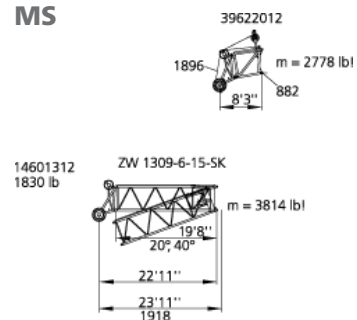

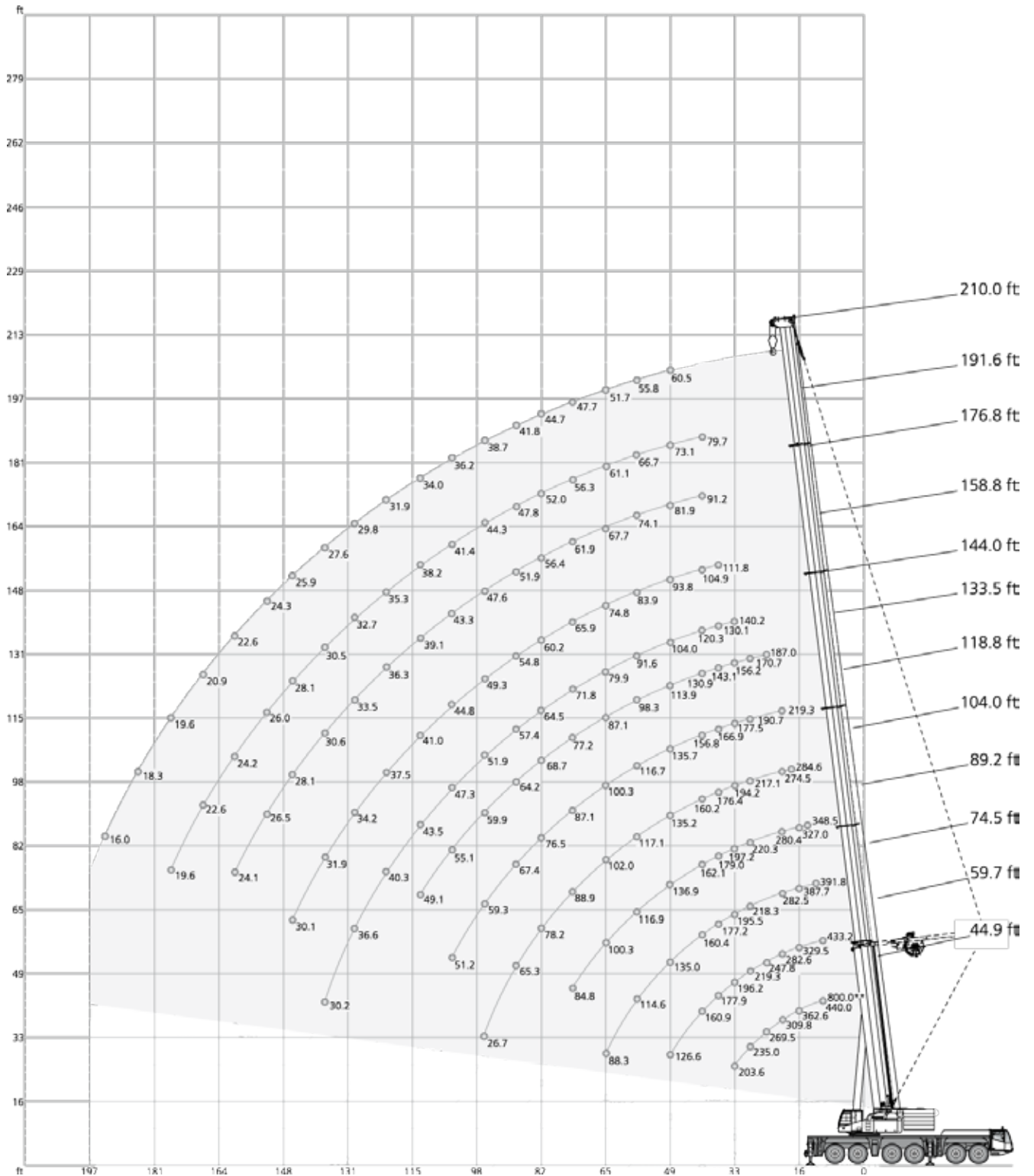
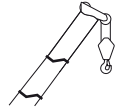

** Capacity class

257,300 lb		28.5 ft x 27.9 ft										360°					85%				
0°		(ft)																			
ft		44.9	44.9	59.7	74.5	89.2	104.0	118.8	118.8*	133.5	133.5*	144.0	148.3*	158.8	163.1*	176.8	177.8*	191.6	192.6*	210.0	210.0*
ft		1,000 lb																			
	800.0**	-	-	-	-	-	-	-	-	-	-	-	-	-	-	-	-	-	-	-	-
10	440.0	437.1	433.2	-	-	-	-	-	-	-	-	-	-	-	-	-	-	-	-	-	-
12	422.6	391.8	392.9	391.8	-	-	-	-	-	-	-	-	-	-	-	-	-	-	-	-	-
14	392.8	357.4	358.5	357.9	348.5	-	-	-	-	-	-	-	-	-	-	-	-	-	-	-	-
16	362.6	328.4	329.5	328.7	327.0	-	-	-	-	-	-	-	-	-	-	-	-	-	-	-	-
18	335.2	304.2	305.3	304.8	303.1	284.6	-	-	-	-	-	-	-	-	-	-	-	-	-	-	-
20	309.8	281.4	282.6	282.5	280.4	274.5	219.3	233.2	-	183.1	-	-	-	-	-	-	-	-	-	-	-
24	269.5	245.5	247.8	246.6	248.1	245.5	204.6	226.1	187.0	176.8	-	149.4	-	-	-	-	-	-	-	-	-
28	235.0	217.3	219.3	218.3	220.3	217.1	190.7	211.1	170.7	170.8	-	144.7	-	119.6	-	100.8	-	-	-	-	-
32	203.6	194.4	196.2	195.5	197.2	194.2	177.5	188.8	156.2	165.2	140.2	140.4	-	116.6	-	98.4	-	77.2	-	-	-
36	-	-	177.9	177.2	179.0	176.4	166.9	171.2	143.1	159.1	130.1	136.2	111.8	113.6	-	95.8	-	75.2	-	58.9	-
40	-	-	160.9	160.4	162.1	160.2	156.8	155.2	130.9	151.9	120.3	132.2	104.9	110.7	91.2	93.3	79.7	73.4	-	57.3	-
48	-	-	126.6	135.0	136.9	135.2	135.7	131.3	113.9	128.2	104.0	123.6	93.8	105.3	81.9	88.6	73.1	69.9	60.5	54.6	-
56	-	-	-	114.6	116.9	117.1	116.7	112.5	98.3	110.1	91.6	108.8	83.9	100.6	74.1	84.6	66.7	66.6	55.8	52.0	-
64	-	-	-	88.3	100.3	102.0	100.3	96.6	87.1	95.3	79.9	94.6	74.8	93.3	67.7	80.8	61.1	63.8	51.7	49.6	-
72	-	-	-	-	84.8	88.9	87.1	83.4	77.2	82.3	71.8	82.5	65.9	82.7	61.9	77.0	56.3	60.9	47.7	47.4	-
80	-	-	-	-	-	78.2	76.5	72.7	68.7	71.6	64.5	71.9	60.2	72.8	56.4	72.3	52.0	58.3	44.7	45.3	-
88	-	-	-	-	-	65.3	67.4	63.3	64.2	62.2	57.4	62.6	54.8	63.5	51.9	64.9	47.8	56.2	41.8	43.3	-
96	-	-	-	-	-	26.7	59.3	54.7	59.9	54.4	51.9	54.7	49.3	55.6	47.6	57.1	44.3	54.1	38.7	41.7	-
104	-	-	-	-	-	-	51.2	43.6	55.1	47.9	47.3	48.2	44.8	49.0	43.3	50.4	41.4	51.3	36.2	40.1	-
112	-	-	-	-	-	-	-	-	49.1	41.3	43.5	42.5	41.0	43.4	39.1	44.7	38.2	46.0	34.0	38.7	-
120	-	-	-	-	-	-	-	-	-	-	40.3	37.4	37.5	38.4	36.3	39.9	35.3	41.2	31.9	37.1	-
128	-	-	-	-	-	-	-	-	-	-	36.6	30.9	34.2	34.3	33.5	35.7	32.7	37.0	29.8	35.3	-
136	-	-	-	-	-	-	-	-	-	-	30.2	21.9	31.9	30.4	30.6	31.9	30.5	33.3	27.6	33.3	-
144	-	-	-	-	-	-	-	-	-	-	-	-	30.1	23.9	28.1	28.6	28.1	30.0	25.9	30.5	-
152	-	-	-	-	-	-	-	-	-	-	-	-	-	-	26.5	25.0	26.0	27.0	24.3	27.4	-
160	-	-	-	-	-	-	-	-	-	-	-	-	-	-	24.1	19.1	24.2	24.4	22.6	24.9	-
168	-	-	-	-	-	-	-	-	-	-	-	-	-	-	-	-	22.6	20.6	20.9	22.5	-
176	-	-	-	-	-	-	-	-	-	-	-	-	-	-	-	-	19.6	15.5	19.6	20.2	-
184	-	-	-	-	-	-	-	-	-	-	-	-	-	-	-	-	-	-	18.3	16.7	-
192	-	-	-	-	-	-	-	-	-	-	-	-	-	-	-	-	-	-	16.0	12.7	-

*  ** Capacity class

☰ 211,400 lb		📏 28.5 ft x 27.9 ft											360°		85%	
📐		44.9 ft	59.7 ft	74.5 ft	89.2 ft	104.0 ft	118.8 ft	133.5 ft	144.0 ft	158.8 ft	176.8 ft	191.6 ft	210.0 ft	📐		
ft	1,000 lb												ft			
10	425.6	426.7	-	-	-	-	-	-	-	-	-	-	-	10		
12	386.3	387.4	386.7	-	-	-	-	-	-	-	-	-	-	12		
14	352.4	353.5	352.9	346.7	-	-	-	-	-	-	-	-	-	14		
16	324.0	325.1	324.0	322.9	-	-	-	-	-	-	-	-	-	16		
18	299.8	301.5	300.4	299.3	284.6	-	-	-	-	-	-	-	-	18		
20	277.1	279.2	278.2	277.3	274.2	219.3	-	-	-	-	-	-	-	20		
24	242.2	243.7	243.3	244.8	243.3	204.6	187.0	-	-	-	-	-	-	24		
28	214.3	216.1	215.3	217.2	215.3	190.7	170.7	-	-	-	-	-	-	28		
32	191.7	193.3	192.6	194.4	192.8	177.5	156.2	140.2	-	-	-	-	-	32		
36	-	175.2	174.4	176.2	174.4	166.9	143.1	130.1	111.8	-	-	-	-	36		
40	-	158.3	157.4	159.2	157.2	156.4	130.9	120.3	104.9	91.2	79.7	-	-	40		
48	-	123.6	131.8	130.7	131.0	130.9	113.9	104.0	93.8	81.9	73.1	60.5	-	48		
56	-	-	110.5	109.4	111.7	109.7	98.3	91.6	83.9	74.1	66.7	55.8	-	56		
64	-	-	87.1	93.1	94.9	92.7	87.1	79.9	74.8	67.7	61.1	51.7	-	64		
72	-	-	-	82.7	81.4	79.2	77.2	71.8	65.9	61.9	56.3	47.7	-	72		
80	-	-	-	-	71.1	68.9	68.6	64.5	60.2	56.4	52.0	44.7	-	80		
88	-	-	-	-	62.2	60.3	62.5	57.4	54.8	51.9	47.8	41.8	-	88		
96	-	-	-	-	26.7	55.1	55.2	51.0	49.3	47.6	44.3	38.7	-	96		
104	-	-	-	-	-	50.9	48.6	46.3	44.8	43.3	41.4	36.2	-	104		
112	-	-	-	-	-	-	43.4	41.0	39.7	39.1	38.2	34.0	-	112		
120	-	-	-	-	-	-	-	37.5	36.8	36.0	35.3	31.9	-	120		
128	-	-	-	-	-	-	-	35.4	33.4	32.2	32.7	29.8	-	128		
136	-	-	-	-	-	-	-	30.0	30.6	29.9	29.7	27.6	-	136		
144	-	-	-	-	-	-	-	-	29.0	27.9	26.6	25.9	-	144		
152	-	-	-	-	-	-	-	-	-	25.2	23.7	23.7	-	152		
160	-	-	-	-	-	-	-	-	-	22.7	21.7	21.1	-	160		
168	-	-	-	-	-	-	-	-	-	-	20.5	18.8	-	168		
176	-	-	-	-	-	-	-	-	-	-	18.8	16.8	-	176		
184	-	-	-	-	-	-	-	-	-	-	-	14.9	-	184		
192	-	-	-	-	-	-	-	-	-	-	-	13.3	-	192		

☰ 165,600 lb		📏 28.5 ft x 27.9 ft		360°		85%								
📏	📏	44.9 ft	59.7 ft	74.5 ft	89.2 ft	104.0 ft	118.8 ft	133.5 ft	144.0 ft	158.8 ft	176.8 ft	191.6 ft	210.0 ft	📏
ft	1,000 lb												ft	
10	420.1	421.2	-	-	-	-	-	-	-	-	-	-	-	10
12	380.8	381.9	381.2	-	-	-	-	-	-	-	-	-	-	12
14	347.5	348.6	348.0	344.3	-	-	-	-	-	-	-	-	-	14
16	318.8	320.7	319.6	318.5	-	-	-	-	-	-	-	-	-	16
18	295.4	297.0	295.9	294.8	284.6	-	-	-	-	-	-	-	-	18
20	273.8	274.9	273.8	276.0	273.9	219.3	-	-	-	-	-	-	-	20
24	239.3	240.4	239.3	241.5	240.0	204.6	187.0	-	-	-	-	-	-	24
28	211.6	212.9	212.1	214.0	212.2	190.7	170.7	-	-	-	-	-	-	28
32	187.3	188.7	187.9	189.8	187.9	177.5	156.2	140.2	-	-	-	-	-	32
36	-	167.5	168.7	168.9	166.8	163.8	143.1	130.1	111.8	-	-	-	-	36
40	-	147.6	150.5	149.4	149.4	149.6	130.9	120.3	104.9	91.2	79.7	-	-	40
48	-	117.5	120.9	120.5	122.2	120.0	113.9	104.0	93.8	81.9	73.1	60.5	-	48
56	-	-	99.6	102.2	100.9	98.7	96.5	91.6	83.9	74.1	66.7	55.8	-	56
64	-	-	82.9	85.3	83.8	81.2	81.9	78.2	74.8	67.7	61.1	51.7	-	64
72	-	-	-	71.3	69.7	69.4	69.5	67.0	65.7	61.9	56.3	47.7	-	72
80	-	-	-	-	59.3	61.4	59.1	56.8	55.6	55.9	52.0	44.7	-	80
88	-	-	-	-	53.4	53.1	50.8	49.0	49.6	48.3	47.8	41.8	-	88
96	-	-	-	-	26.7	46.4	44.7	44.7	43.1	43.6	42.9	38.7	-	96
104	-	-	-	-	-	41.0	39.9	39.5	39.3	38.8	37.5	36.2	-	104
112	-	-	-	-	-	-	36.8	34.8	34.9	33.9	32.7	32.6	-	112
120	-	-	-	-	-	-	-	31.7	31.8	30.0	29.9	28.4	-	120
128	-	-	-	-	-	-	-	29.3	28.3	26.6	26.8	24.8	-	128
136	-	-	-	-	-	-	-	26.2	25.1	24.5	23.6	21.6	-	136
144	-	-	-	-	-	-	-	-	23.2	22.6	20.8	18.9	-	144
152	-	-	-	-	-	-	-	-	-	20.2	18.2	16.4	-	152
160	-	-	-	-	-	-	-	-	-	18.1	16.1	14.2	-	160
168	-	-	-	-	-	-	-	-	-	-	14.2	12.3	-	168
176	-	-	-	-	-	-	-	-	-	-	12.4	10.4	-	176
184	-	-	-	-	-	-	-	-	-	-	-	9.0	-	184
192	-	-	-	-	-	-	-	-	-	-	-	7.5	-	192

☰ 119,700 lb		🏗️ 28.5 ft x 27.9 ft											360°		85%	
🏗️ 🏗️		44.9 ft	59.7 ft	74.5 ft	89.2 ft	104.0 ft	118.8 ft	133.5 ft	144.0 ft	158.8 ft	176.8 ft	191.6 ft	210.0 ft	🏗️		
ft	1,000 lb												ft			
10	414.6	415.7	-	-	-	-	-	-	-	-	-	-	-	10		
12	375.7	376.8	375.7	-	-	-	-	-	-	-	-	-	-	12		
14	342.5	343.6	343.1	342.0	-	-	-	-	-	-	-	-	-	14		
16	314.1	316.0	315.2	314.1	-	-	-	-	-	-	-	-	-	16		
18	291.0	292.6	292.1	291.0	283.0	-	-	-	-	-	-	-	-	18		
20	269.5	270.6	270.5	271.7	270.5	219.3	-	-	-	-	-	-	-	20		
24	234.9	236.1	235.1	237.2	235.1	204.6	187.0	-	-	-	-	-	-	24		
28	200.9	202.9	204.2	204.4	202.2	190.7	170.7	-	-	-	-	-	-	28		
32	170.7	173.1	176.0	174.9	174.5	173.7	156.2	140.2	-	-	-	-	-	32		
36	-	152.1	154.0	152.9	155.6	153.3	141.4	130.1	111.8	-	-	-	-	36		
40	-	133.3	133.9	136.8	135.5	133.2	126.4	119.7	104.9	91.2	79.7	-	-	40		
48	-	102.8	103.9	104.4	102.9	100.0	99.7	95.0	92.0	81.9	73.1	60.5	-	48		
56	-	-	82.2	81.9	80.3	82.0	80.3	77.6	75.1	72.9	66.7	55.8	-	56		
64	-	-	66.5	66.2	67.7	67.0	64.8	64.2	63.1	61.7	60.9	51.7	-	64		
72	-	-	-	55.9	56.7	55.1	54.4	53.6	53.9	52.9	51.6	47.7	-	72		
80	-	-	-	-	48.0	46.9	47.3	47.1	46.0	44.3	44.2	42.9	-	80		
88	-	-	-	-	41.1	41.1	40.3	40.0	39.1	39.3	37.8	36.1	-	88		
96	-	-	-	-	26.7	36.2	35.7	34.4	34.9	34.0	32.2	30.3	-	96		
104	-	-	-	-	-	31.6	31.2	30.3	30.3	29.2	27.3	25.3	-	104		
112	-	-	-	-	-	-	27.4	27.6	26.3	25.2	23.2	21.2	-	112		
120	-	-	-	-	-	-	-	24.2	22.9	21.7	19.8	17.8	-	120		
128	-	-	-	-	-	-	-	21.4	20.0	18.7	16.8	15.0	-	128		
136	-	-	-	-	-	-	-	17.1	17.4	16.2	14.2	12.4	-	136		
144	-	-	-	-	-	-	-	-	15.3	14.0	12.0	10.0	-	144		
152	-	-	-	-	-	-	-	-	-	11.9	10.1	8.2	-	152		
160	-	-	-	-	-	-	-	-	-	10.3	8.3	6.5	-	160		
168	-	-	-	-	-	-	-	-	-	-	6.8	4.9	-	168		
176	-	-	-	-	-	-	-	-	-	-	5.5	3.5	-	176		

98,800 lb		28.5 ft x 27.9 ft										360°		85%	
ft		44.9 ft	59.7 ft	74.5 ft	89.2 ft	104.0 ft	118.8 ft	133.5 ft	144.0 ft	158.8 ft	176.8 ft	191.6 ft	210.0 ft	ft	
1,000 lb															
10	411.3	412.4	-	-	-	-	-	-	-	-	-	-	-	-	10
12	372.7	373.8	373.4	-	-	-	-	-	-	-	-	-	-	-	12
14	340.3	341.4	340.9	339.8	-	-	-	-	-	-	-	-	-	-	14
16	312.7	313.8	313.0	311.9	-	-	-	-	-	-	-	-	-	-	16
18	289.9	291.0	289.9	288.8	281.9	-	-	-	-	-	-	-	-	-	18
20	268.1	269.3	268.2	270.4	268.2	219.3	-	-	-	-	-	-	-	-	20
24	228.5	230.8	231.0	232.1	229.8	204.6	187.0	-	-	-	-	-	-	-	24
28	190.8	193.1	195.9	194.7	192.4	186.0	170.7	-	-	-	-	-	-	-	28
32	161.7	166.1	166.7	165.6	167.6	159.2	148.7	139.4	-	-	-	-	-	-	32
36	-	141.8	142.6	143.9	144.3	137.1	129.0	122.5	111.3	-	-	-	-	-	36
40	-	121.5	122.6	123.6	121.9	119.2	113.1	107.0	102.8	91.1	79.7	-	-	-	40
48	-	90.3	92.3	92.1	90.3	92.5	90.3	84.5	82.4	78.8	73.0	60.5	-	-	48
56	-	-	71.6	71.3	73.9	72.1	70.5	70.2	67.9	66.1	63.5	55.8	-	-	56
64	-	-	57.9	59.4	59.3	58.0	57.8	57.6	57.2	55.1	52.1	49.7	-	-	64
72	-	-	-	49.6	48.5	49.3	48.9	47.6	46.7	47.1	45.4	41.8	-	-	72
80	-	-	-	-	40.8	41.5	41.1	39.9	40.4	39.3	37.6	35.0	-	-	80
88	-	-	-	-	35.9	35.4	35.0	35.3	34.3	33.2	31.4	29.3	-	-	88
96	-	-	-	-	26.7	30.5	30.0	30.5	29.2	28.1	26.2	24.2	-	-	96
104	-	-	-	-	-	26.7	25.9	26.3	24.8	23.7	21.7	19.7	-	-	104
112	-	-	-	-	-	-	22.1	22.5	21.2	20.1	18.1	16.1	-	-	112
120	-	-	-	-	-	-	-	19.6	18.1	17.0	15.0	13.0	-	-	120
128	-	-	-	-	-	-	-	17.0	15.5	14.4	12.4	10.5	-	-	128
136	-	-	-	-	-	-	-	13.0	13.3	12.0	10.2	8.2	-	-	136
144	-	-	-	-	-	-	-	-	11.3	10.0	8.0	6.0	-	-	144
152	-	-	-	-	-	-	-	-	-	8.2	6.4	-	-	-	152
160	-	-	-	-	-	-	-	-	-	6.8	4.9	-	-	-	160

76,500 lb		28.5 ft x 27.9 ft											360°		85%	
ft		44.9 ft	59.7 ft	74.5 ft	89.2 ft	104.0 ft	118.8 ft	133.5 ft	144.0 ft	158.8 ft	176.8 ft	191.6 ft	210.0 ft	ft		
1,000 lb																
10	409.1	410.2	-	-	-	-	-	-	-	-	-	-	-	10		
12	370.5	371.6	370.5	-	-	-	-	-	-	-	-	-	-	12		
14	338.1	339.2	338.7	337.6	-	-	-	-	-	-	-	-	-	14		
16	310.5	311.6	310.8	309.7	-	-	-	-	-	-	-	-	-	16		
18	287.7	288.8	287.7	287.6	281.4	-	-	-	-	-	-	-	-	18		
20	264.9	266.2	265.0	267.3	265.4	219.3	-	-	-	-	-	-	-	20		
24	216.5	218.7	221.1	220.0	209.6	198.8	182.9	-	-	-	-	-	-	24		
28	179.5	184.1	184.7	181.9	177.8	163.8	153.0	-	-	-	-	-	-	28		
32	145.7	151.2	152.0	155.4	147.3	137.7	128.5	121.8	-	-	-	-	-	32		
36	-	127.4	127.8	129.7	124.8	118.4	113.2	105.6	98.8	-	-	-	-	36		
40	-	104.2	106.4	106.4	104.4	105.3	97.5	94.4	88.5	83.0	79.1	-	-	40		
48	-	75.6	77.6	78.1	80.4	78.5	76.9	74.0	72.9	68.3	64.2	59.3	-	48		
56	-	-	61.1	62.5	61.7	60.7	61.1	60.9	58.7	56.1	53.7	49.2	-	56		
64	-	-	48.9	49.9	49.4	49.9	49.5	48.3	48.5	47.3	43.6	39.5	-	64		
72	-	-	-	40.8	41.2	40.8	40.3	40.7	39.4	38.3	35.7	31.9	-	72		
80	-	-	-	-	34.3	34.3	33.5	33.9	32.6	31.5	29.3	25.9	-	80		
88	-	-	-	-	28.9	28.8	27.8	28.4	26.9	25.8	23.6	21.0	-	88		
96	-	-	-	-	24.9	24.2	23.1	23.7	22.2	21.1	19.1	16.9	-	96		
104	-	-	-	-	-	20.3	19.4	19.8	18.3	17.2	15.2	13.2	-	104		
112	-	-	-	-	-	-	16.2	16.6	15.3	14.0	12.0	10.0	-	112		
120	-	-	-	-	-	-	-	14.0	12.5	11.3	9.3	7.4	-	120		
128	-	-	-	-	-	-	-	11.7	10.3	9.0	7.2	5.2	-	128		
136	-	-	-	-	-	-	-	7.9	8.4	7.0	5.1	-	-	136		
144	-	-	-	-	-	-	-	-	6.7	5.4	3.4	-	-	144		

54,200 lb		28.5 ft x 27.9 ft											360°		85%	
ft		44.9 ft	59.7 ft	74.5 ft	89.2 ft	104.0 ft	118.8 ft	133.5 ft	144.0 ft	158.8 ft	176.8 ft	191.6 ft	210.0 ft	ft		
1,000 lb																
10	405.9	407.0	-	-	-	-	-	-	-	-	-	-	-	10		
12	367.9	369.0	368.3	-	-	-	-	-	-	-	-	-	-	12		
14	335.4	336.5	336.5	334.8	-	-	-	-	-	-	-	-	-	14		
16	308.3	309.4	308.6	307.2	-	-	-	-	-	-	-	-	-	16		
18	280.6	282.3	281.2	282.8	264.3	-	-	-	-	-	-	-	-	18		
20	252.7	254.9	258.2	256.0	230.2	216.6	-	-	-	-	-	-	-	20		
24	203.4	207.9	207.4	194.4	186.9	170.0	158.7	-	-	-	-	-	-	24		
28	160.3	166.0	165.1	160.9	148.9	138.4	131.0	-	-	-	-	-	-	28		
32	121.8	130.8	133.5	130.5	121.5	118.4	109.7	104.5	-	-	-	-	-	32		
36	-	106.0	108.6	107.6	105.2	100.9	95.0	89.5	86.5	-	-	-	-	36		
40	-	84.8	87.4	90.9	90.4	86.1	83.7	80.0	75.4	70.3	68.1	-	-	40		
48	-	60.5	64.6	66.5	65.5	66.5	65.3	61.3	60.6	56.4	51.7	46.7	-	48		
56	-	-	49.6	50.4	50.9	50.4	50.0	50.5	47.4	44.0	40.0	35.8	-	56		
64	-	-	38.4	39.3	39.9	39.7	38.8	39.3	37.7	35.0	31.3	27.5	-	64		
72	-	-	-	31.3	32.1	31.5	30.6	31.3	29.7	27.9	24.6	21.3	-	72		
80	-	-	-	-	26.1	25.6	24.5	25.2	23.7	22.3	19.6	16.3	-	80		
88	-	-	-	-	21.3	20.7	19.7	20.2	18.8	17.5	15.4	12.3	-	88		
96	-	-	-	-	17.6	16.8	15.8	16.3	14.9	13.6	11.6	8.9	-	96		
104	-	-	-	-	-	13.6	12.7	13.2	11.6	10.5	8.5	6.1	-	104		
112	-	-	-	-	-	-	10.0	10.5	9.1	7.8	5.8	-	-	112		
120	-	-	-	-	-	-	-	8.3	6.8	5.7	-	-	-	120		
128	-	-	-	-	-	-	-	6.4	5.1	-	-	-	-	128		

☰ 39,900 lb		🏗️ 28.5 ft x 27.9 ft										360°		85%	
🏗️ 🏗️		44.9 ft	59.7 ft	74.5 ft	89.2 ft	104.0 ft	118.8 ft	133.5 ft	144.0 ft	158.8 ft	176.8 ft	191.6 ft	210.0 ft	🏗️	
ft	1,000 lb												ft		
10	404.7	404.8	-	-	-	-	-	-	-	-	-	-	-	10	
12	366.1	367.2	366.8	-	-	-	-	-	-	-	-	-	-	12	
14	334.3	335.4	334.3	333.2	-	-	-	-	-	-	-	-	-	14	
16	306.4	308.3	307.2	306.1	-	-	-	-	-	-	-	-	-	16	
18	274.1	276.3	275.8	268.8	242.7	-	-	-	-	-	-	-	-	18	
20	241.9	244.1	246.4	227.8	215.5	193.8	-	-	-	-	-	-	-	20	
24	190.6	195.9	187.3	179.5	164.2	153.0	141.7	-	-	-	-	-	-	24	
28	140.5	150.8	150.0	139.7	130.4	124.8	116.3	-	-	-	-	-	-	28	
32	104.5	113.8	116.4	112.2	110.4	102.7	97.0	92.9	82.1	-	-	-	-	32	
36	-	91.2	93.8	94.2	93.2	86.9	84.2	79.3	74.4	-	-	-	-	36	
40	-	72.4	77.0	79.2	77.9	76.2	72.1	69.2	65.6	60.7	55.2	-	-	40	
48	-	50.1	55.4	56.5	57.1	56.3	53.9	53.2	49.4	45.4	41.0	36.3	-	48	
56	-	-	40.7	41.8	42.9	42.2	41.1	41.2	37.9	34.8	31.1	26.9	-	56	
64	-	-	30.8	31.8	32.9	32.4	31.3	31.9	29.7	27.0	23.6	19.8	-	64	
72	-	-	-	24.6	25.7	25.1	24.2	24.6	23.1	20.9	17.8	14.4	-	72	
80	-	-	-	-	20.3	19.6	18.7	19.2	17.8	16.3	13.3	10.2	-	80	
88	-	-	-	-	16.1	15.5	14.5	15.0	13.5	12.3	9.7	6.7	-	88	
96	-	-	-	-	12.8	12.1	11.1	11.6	10.2	8.9	6.8	-	-	96	
104	-	-	-	-	-	9.4	8.3	8.9	7.4	6.3	4.3	-	-	104	
112	-	-	-	-	-	-	6.1	6.5	5.2	-	-	-	-	112	
120	-	-	-	-	-	-	-	4.7	-	-	-	-	-	120	

☰ 32,000 lb		🏗️ 28.5 ft x 27.9 ft										360°		85%	
🏗️ 🏗️		44.9 ft	59.7 ft	74.5 ft	89.2 ft	104.0 ft	118.8 ft	133.5 ft	144.0 ft	158.8 ft	176.8 ft	191.6 ft	210.0 ft	🏗️	
ft	1,000 lb												ft		
10	403.6	404.7	-	-	-	-	-	-	-	-	-	-	-	10	
12	365.0	366.1	366.1	-	-	-	-	-	-	-	-	-	-	12	
14	333.2	334.3	334.3	332.1	-	-	-	-	-	-	-	-	-	14	
16	305.3	307.2	306.4	297.0	-	-	-	-	-	-	-	-	-	16	
18	270.9	273.1	267.5	254.5	225.0	-	-	-	-	-	-	-	-	18	
20	236.4	240.5	235.0	216.2	199.9	182.4	-	-	-	-	-	-	-	20	
24	183.3	186.2	177.7	165.1	149.5	141.8	130.5	-	-	-	-	-	-	24	
28	128.5	138.7	136.7	127.1	123.1	113.9	105.9	88.5	-	-	-	-	-	28	
32	94.0	103.4	106.1	105.8	100.4	94.5	90.5	84.0	80.3	-	-	-	-	32	
36	-	82.3	86.3	88.1	83.8	81.1	76.6	72.0	69.0	-	-	-	-	36	
40	-	64.7	70.6	72.0	71.2	67.5	63.8	62.6	57.8	53.1	47.9	-	-	40	
48	-	43.6	48.9	50.0	51.3	49.6	47.2	46.6	42.9	39.3	35.1	30.4	-	48	
56	-	-	35.5	36.5	37.7	37.2	35.8	35.7	32.5	29.5	25.9	22.0	-	56	
64	-	-	26.5	27.4	28.7	28.1	27.0	27.5	24.9	22.5	19.1	15.5	-	64	
72	-	-	-	20.9	22.0	21.3	20.2	20.9	19.3	16.9	13.8	10.5	-	72	
80	-	-	-	-	17.0	16.3	15.2	15.9	14.4	12.7	9.8	6.8	-	80	
88	-	-	-	-	13.2	12.5	11.5	12.0	10.5	9.3	6.5	-	-	88	
96	-	-	-	-	10.1	9.4	8.4	8.8	7.4	6.3	-	-	-	96	
104	-	-	-	-	-	6.9	6.0	6.4	4.9	3.8	-	-	-	104	

17,600 lb		28.5 ft x 27.9 ft											360°		85%	
ft		44.9 ft	59.7 ft	74.5 ft	89.2 ft	104.0 ft	118.8 ft	133.5 ft	144.0 ft	158.8 ft	176.8 ft	191.6 ft	210.0 ft	ft		
ft		1,000 lb											ft			
10	401.5	402.6	-	-	-	-	-	-	-	-	-	-	-	10		
12	363.9	365.0	363.9	-	-	-	-	-	-	-	-	-	-	12		
14	332.1	333.2	320.3	288.0	-	-	-	-	-	-	-	-	-	14		
16	295.0	296.9	270.7	238.0	-	-	-	-	-	-	-	-	-	16		
18	259.3	250.0	224.7	204.4	178.8	-	-	-	-	-	-	-	-	18		
20	223.2	209.3	193.2	170.9	154.0	141.2	-	-	-	-	-	-	-	20		
24	141.7	150.8	140.7	129.7	120.9	111.6	103.4	-	-	-	-	-	-	24		
28	96.4	105.9	106.6	103.9	95.8	89.4	82.1	78.7	-	-	-	-	-	28		
32	68.9	77.7	83.4	82.4	78.2	72.1	66.5	64.3	58.2	-	-	-	-	32		
36	-	60.4	66.2	66.4	64.9	60.3	55.9	54.3	49.0	-	-	-	-	36		
40	-	45.8	51.3	52.6	53.3	50.0	46.6	45.5	41.0	36.6	31.6	-	-	40		
48	-	30.0	34.7	35.7	36.8	36.0	34.1	33.5	29.9	26.4	22.3	-	-	48		
56	-	-	24.7	25.6	26.6	26.0	25.1	25.2	22.0	19.1	15.5	-	-	56		
64	-	-	18.0	18.7	19.7	19.1	18.4	18.8	16.2	13.6	10.4	-	-	64		
72	-	-	-	14.0	14.9	14.2	13.5	14.0	11.8	9.3	6.5	-	-	72		
80	-	-	-	-	11.2	10.8	9.9	10.3	8.4	6.2	-	-	-	80		
88	-	-	-	-	8.4	7.9	6.9	7.4	5.6	-	-	-	-	88		
96	-	-	-	-	6.0	5.4	4.3	4.7	-	-	-	-	-	96		

0 lb		28.5 ft x 27.9 ft											360°		85%	
ft		44.9 ft	59.7 ft	74.5 ft	89.2 ft	104.0 ft	118.8 ft	133.5 ft	144.0 ft	158.8 ft	176.8 ft	191.6 ft	210.0 ft	ft		
ft		1,000 lb											ft			
10	399.3	400.4	-	-	-	-	-	-	-	-	-	-	-	10		
12	361.7	362.8	353.3	-	-	-	-	-	-	-	-	-	-	12		
14	324.6	324.5	293.3	250.2	-	-	-	-	-	-	-	-	-	14		
16	280.4	263.9	232.5	205.5	-	-	-	-	-	-	-	-	-	16		
18	234.7	216.3	195.7	169.7	151.3	-	-	-	-	-	-	-	-	18		
20	189.7	176.1	157.6	145.7	129.3	118.4	-	-	-	-	-	-	-	20		
24	115.8	121.8	116.1	106.2	97.5	87.6	78.9	-	-	-	-	-	-	24		
28	74.2	84.7	85.2	79.5	74.4	67.6	61.5	59.2	-	-	-	-	-	28		
32	49.5	58.9	64.6	61.8	58.8	53.6	49.2	47.5	42.2	-	-	-	-	32		
36	-	44.5	50.4	49.8	48.3	44.2	40.6	39.4	34.9	-	-	-	-	36		
40	-	32.9	38.1	39.4	39.0	35.9	33.1	32.3	28.3	24.5	-	-	-	40		
48	-	20.2	24.9	25.8	27.0	25.2	22.9	22.7	19.4	16.3	-	-	-	48		
56	-	-	16.8	17.7	18.7	17.9	16.0	16.0	13.1	10.4	-	-	-	56		
64	-	-	11.3	12.2	13.1	12.7	10.9	11.1	8.4	6.1	-	-	-	64		
72	-	-	-	8.2	9.1	8.7	7.1	7.1	4.9	-	-	-	-	72		
80	-	-	-	-	6.0	5.3	-	-	-	-	-	-	-	80		

HAV/HAV-SL

AC 350-6

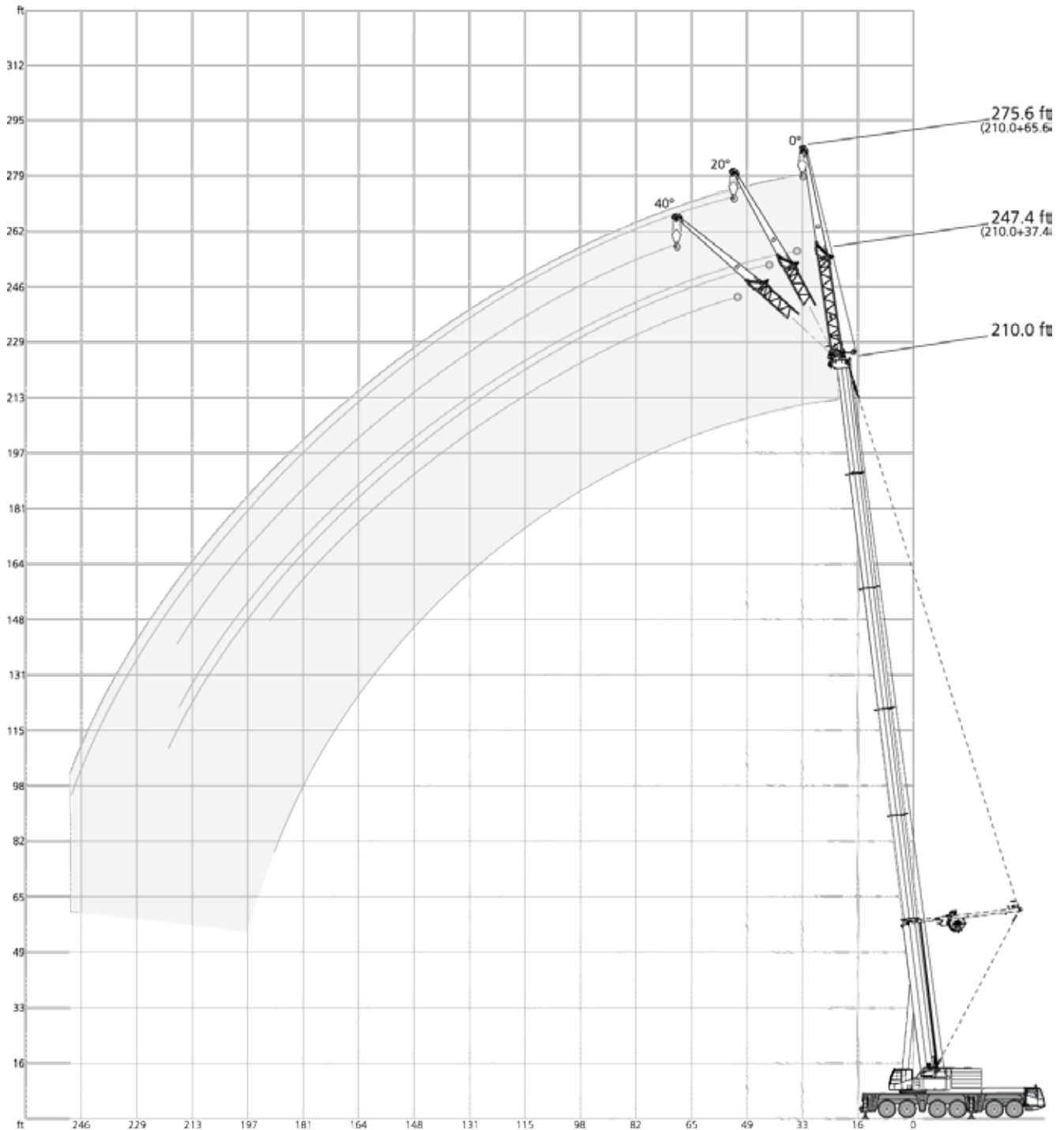
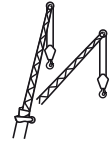

28.5 ft x 27.9 ft							360°							85%	
44.9 ft							118.8 ft								
ft	37.4 ft			65.6 ft			ft	37.4 ft			65.6 ft				
	0°	20°	40°	0°	20°	40°		0°	20°	40°	0°	20°	40°		
														1,000 lb	
10	50.5	-	-	-	-	-	28	50.5	-	-	-	-	-	-	
12	50.5	-	-	-	-	-	32	50.5	-	-	35.4	-	-	-	
14	50.5	-	-	-	-	-	36	50.5	-	-	33.7	-	-	-	
16	50.5	-	-	42.3	-	-	40	50.5	50.1	-	31.9	-	-	-	
18	50.5	-	-	40.3	-	-	48	49.8	47.5	-	28.8	-	-	-	
20	50.5	-	-	38.3	-	-	56	47.1	44.3	34.6	26.2	18.3	-	-	
24	50.5	50.5	-	35.2	-	-	64	44.4	40.8	33.0	24.2	17.2	-	-	
28	50.5	50.5	-	32.3	-	-	72	40.9	37.3	31.8	22.1	16.3	-	-	
32	50.5	49.8	-	30.0	-	-	80	37.1	34.2	30.7	20.3	15.5	13.0	-	
36	50.5	47.6	38.6	27.7	-	-	88	33.1	31.7	29.3	19.3	14.8	12.6	-	
40	50.5	45.0	36.5	25.5	19.7	-	96	29.8	29.2	28.0	18.0	14.3	12.3	-	
48	48.9	40.3	33.3	22.2	17.9	-	104	27.2	26.8	26.4	16.9	13.7	12.2	-	
56	42.8	36.3	31.0	19.7	16.3	-	112	24.8	24.6	24.6	15.8	13.2	11.9	-	
64	37.6	33.2	29.7	17.6	15.0	13.2	120	22.4	22.5	22.7	15.1	12.9	11.8	-	
72	33.4	31.3	-	15.9	13.9	12.6	128	20.6	20.6	-	14.4	12.5	11.7	-	
80	-	-	-	14.6	13.1	12.1	136	19.1	19.0	-	13.8	12.2	11.7	-	
88	-	-	-	13.6	12.5	11.9	144	17.7	17.5	-	13.0	11.9	11.7	-	
96	-	-	-	12.8	12.1	-	152	-	-	-	12.8	11.9	-	-	
							160	-	-	-	12.5	11.7	-	-	
							168	-	-	-	12.2	11.7	-	-	

177.8 ft							192.6 ft								
ft	37.4 ft			65.6 ft			ft	37.4 ft			65.6 ft				
	0°	20°	40°	0°	20°	40°		0°	20°	40°	0°	20°	40°		
														1,000 lb	
48	50.5	-	-	28.5	-	-	56	43.6	-	-	25.3	-	-		
56	49.8	-	-	27.2	-	-	64	40.5	-	-	24.4	-	-		
64	47.2	41.6	-	25.7	-	-	72	37.5	34.0	-	23.2	-	-		
72	43.9	39.5	32.0	24.1	-	-	80	34.8	31.8	29.8	21.9	16.0	-		
80	41.0	37.1	30.9	22.5	16.2	-	88	32.8	29.8	28.3	20.8	15.5	-		
88	38.0	34.9	29.9	21.4	15.6	12.7	96	30.6	28.0	26.7	19.9	14.9	12.4		
96	35.1	33.0	29.3	20.2	14.9	12.4	104	28.5	26.6	25.3	19.1	14.4	12.2		
104	32.5	31.1	28.5	19.1	14.6	12.2	112	26.6	25.0	24.2	18.0	14.1	11.9		
112	30.5	29.2	27.7	18.0	14.1	12.1	120	25.2	23.6	22.9	17.2	13.6	11.8		
120	28.4	27.6	26.8	17.3	13.6	11.9	128	23.7	22.5	21.8	16.5	13.3	11.7		
128	26.4	25.8	25.5	16.6	13.3	11.8	136	22.2	21.4	20.9	16.0	12.9	11.7		
136	24.3	24.2	24.1	16.0	13.1	11.7	144	20.8	20.1	19.9	15.5	12.6	11.5		
144	22.6	22.6	22.8	15.2	12.8	11.7	152	19.3	19.0	19.1	14.9	12.5	11.5		
152	20.9	21.0	21.2	14.7	12.5	11.7	160	18.2	18.0	18.2	14.4	12.3	11.5		
160	19.3	19.6	19.8	14.0	12.3	11.7	168	17.0	16.9	17.1	13.8	12.0	11.5		
168	17.7	18.1	18.2	13.8	12.0	11.7	176	15.8	15.8	16.0	13.3	11.9	11.5		
176	16.1	16.5	16.5	13.3	11.9	11.7	184	14.5	14.7	14.9	13.0	11.7	11.5		
184	14.9	15.2	-	13.0	11.7	11.7	192	13.4	13.7	-	12.5	11.5	11.5		
192	13.3	13.8	-	12.5	11.7	11.7	200	12.4	12.6	-	12.1	11.4	11.5		
200	9.5	10.9	-	12.1	11.7	11.7	208	10.7	11.5	-	11.8	11.2	11.5		
208	-	-	-	11.6	11.5	-	216	6.9	8.0	-	11.3	11.0	11.5		
216	-	-	-	11.1	11.1	-	224	-	-	-	10.5	10.7	-		
224	-	-	-	9.5	10.3	-	232	-	-	-	9.2	9.7	-		
							240	-	-	-	6.8	8.2	-		

32,000lb 39,900lb 54,200lb 76,500lb 98,800lb 119,700lb 165,600lb 211,400lb 257,300lb

		28.5 ft x 27.9 ft						360°		85%	
210.0 ft											
ft	M	37.4 ft			65.6 ft						
		0°	20°	40°	0°	20°	40°				
1,000 lb											
56		35.8	-	-	-	-	-				
64		33.3	-	-	22.4	-	-				
72		31.1	-	-	21.8	-	-				
80		28.8	26.4	25.1	21.0	-	-				
88		26.7	24.7	23.6	20.2	15.3	-				
96		25.0	23.1	22.2	19.4	14.7	-				
104		23.3	21.8	20.9	18.6	14.4	12.1				
112		21.7	20.4	19.8	17.8	13.9	11.9				
120		20.2	19.3	18.7	17.0	13.6	11.8				
128		19.2	18.1	17.6	16.2	13.2	11.7				
136		18.1	17.2	16.7	15.4	12.8	11.5				
144		17.0	16.4	15.9	14.6	12.6	11.5				
152		16.0	15.5	15.1	13.8	12.3	11.5				
160		15.1	14.5	14.5	13.2	12.0	11.4				
168		14.2	13.7	13.7	12.4	11.4	11.1				
176		13.3	13.1	13.1	11.8	10.9	10.7				
184		12.5	12.3	12.3	11.0	10.6	10.4				
192		11.7	11.7	11.8	10.5	10.0	10.0				
200		10.9	11.0	11.1	10.0	9.6	9.6				
208		10.1	10.3	-	9.6	9.3	9.3				
216		9.3	9.5	-	9.1	8.9	9.1				
224		8.2	8.4	-	8.6	8.6	8.8				
232		-	-	-	8.2	8.2	-				
240		-	-	-	7.7	7.7	-				
248		-	-	-	6.5	7.1	-				

- 32,000lb
- 39,900lb
- 54,200lb
- 76,500lb
- 98,800lb
- 119,700lb
- 165,600lb
- 211,400lb
- 257,300lb

 **28.5 ft x 27.9 ft**

118.8 ft

ft	37.4 ft			65.6 ft		
	0°	20°	40°	0°	20°	40°
	1,000 lb					
24	50.5	-	-	-	-	-
28	50.5	-	-	40.0	-	-
32	50.5	-	-	38.1	-	-
36	50.5	-	-	36.3	-	-
40	50.5	50.4	-	34.5	-	-
48	50.5	49.8	38.0	31.1	-	-
56	50.5	47.9	36.0	28.4	18.8	-
64	50.2	44.7	34.3	25.8	17.6	-
72	49.2	41.7	32.9	23.2	16.8	13.5
80	48.3	39.8	31.6	21.8	16.0	13.1
88	47.2	37.7	30.6	20.3	15.2	12.7
96	45.0	35.7	29.8	18.9	14.6	12.4
104	42.2	34.3	29.0	17.6	14.2	12.2
112	39.5	33.0	28.6	16.5	13.6	12.1
120	36.8	31.9	28.4	15.7	13.1	11.8
128	34.5	31.0	-	14.9	12.7	11.7
136	29.4	30.5	-	14.1	12.4	11.7
144	21.3	24.2	-	13.5	12.1	11.7
152	-	-	-	13.0	11.9	-
160	-	-	-	12.6	11.9	-
168	-	-	-	12.1	11.9	-

360° **85%**

177.8 ft

ft	37.4 ft			65.6 ft		
	0°	20°	40°	0°	20°	40°
	1,000 lb					
36	50.5	-	-	-	-	-
40	50.4	-	-	29.9	-	-
48	49.7	46.6	-	28.5	-	-
56	48.4	44.6	-	27.3	-	-
64	46.8	42.9	34.0	26.1	-	-
72	45.0	41.3	32.9	24.9	17.7	-
80	43.4	39.9	31.8	23.9	17.1	13.4
88	41.8	38.6	31.0	22.8	16.4	12.9
96	40.3	37.2	30.1	21.7	15.8	12.6
104	39.0	36.1	29.2	20.8	15.3	12.6
112	37.6	35.0	28.6	19.8	14.7	12.3
120	36.3	33.9	28.2	18.9	14.2	12.1
128	33.8	33.0	27.8	18.0	13.8	11.9
136	30.1	31.3	27.2	17.2	13.5	11.7
144	26.6	28.2	26.7	16.1	13.2	11.7
152	23.7	25.2	25.8	15.6	12.8	11.7
160	21.1	22.3	23.0	15.0	12.5	11.6
168	18.6	19.7	20.3	14.5	12.3	11.5
176	16.6	17.3	-	14.0	12.2	11.5
184	14.4	15.4	-	13.4	11.9	11.5
192	11.0	12.6	-	12.9	11.8	11.5
200	-	-	-	12.7	11.7	-
208	-	-	-	12.1	11.7	-
216	-	-	-	9.9	11.7	-
224	-	-	-	-	8.8	-

192.6 ft

ft	37.4 ft			65.6 ft		
	0°	20°	40°	0°	20°	40°
	1,000 lb					
40	42.2	-	-	-	-	-
48	40.3	-	-	25.6	-	-
56	38.5	39.2	-	24.7	-	-
64	36.9	37.6	32.8	23.8	-	-
72	35.5	36.0	31.8	22.7	17.7	-
80	34.2	34.6	30.7	22.1	16.9	-
88	32.8	33.4	29.9	21.3	16.4	12.9
96	31.5	32.2	29.1	20.5	15.8	12.6
104	30.3	30.8	28.5	19.9	15.3	12.4
112	29.5	29.9	27.7	19.1	14.8	12.3
120	28.4	28.9	27.3	18.5	14.4	12.1
128	27.3	28.0	27.0	17.9	13.9	12.0
136	26.4	27.1	26.6	17.2	13.5	11.7
144	25.6	26.1	26.2	16.6	13.2	11.7
152	24.4	25.1	25.6	16.0	13.0	11.7
160	21.9	23.2	23.8	15.3	12.7	11.7
168	19.5	20.6	21.3	14.9	12.4	11.6
176	17.3	18.4	18.9	14.4	12.2	11.5
184	15.4	16.2	-	14.1	12.1	11.5
192	13.5	14.1	-	13.6	11.9	11.5
200	11.3	12.3	-	13.1	11.8	11.5
208	8.1	9.5	-	12.7	11.7	11.5
216	-	5.2	-	11.4	11.7	-
224	-	-	-	9.9	11.1	-
232	-	-	-	7.4	9.1	-
240	-	-	-	-	6.1	-

210.0 ft

ft	37.4 ft			65.6 ft		
	0°	20°	40°	0°	20°	40°
	1,000 lb					
40	33.8	-	-	-	-	-
48	32.2	-	-	22.0	-	-
56	30.7	31.2	-	21.6	-	-
64	29.2	29.6	-	21.1	-	-
72	27.8	28.2	29.3	20.3	-	-
80	26.7	27.1	28.0	19.5	16.9	-
88	25.6	25.9	26.9	19.0	16.4	-
96	24.4	24.8	25.8	18.5	15.8	12.6
104	23.3	23.7	24.8	17.9	15.3	12.4
112	22.4	22.7	23.7	17.4	14.8	12.3
120	21.6	21.9	22.7	16.7	14.4	12.1
128	20.8	21.0	21.9	16.3	14.0	11.9
136	20.0	20.2	21.1	15.8	13.6	11.7
144	19.0	19.6	20.3	15.2	13.4	11.7
152	18.4	18.9	19.7	14.7	13.2	11.7
160	17.9	18.1	18.9	14.2	12.9	11.6
168	17.4	17.6	18.3	13.6	12.7	11.5
176	16.7	17.1	17.7	13.3	12.4	11.5
184	15.1	16.0	16.7	13.0	12.1	11.5
192	13.3	14.1	14.6	12.7	12.1	11.5
200	11.4	12.3	-	12.2	11.9	11.5
208	9.7	10.4	-	12.0	11.8	11.5
216	8.0	8.7	-	10.9	11.7	11.5
224	-	6.7	-	9.5	10.8	-
232	-	-	-	8.2	9.3	-
240	-	-	-	7.0	8.0	-
248	-	-	-	5.0	6.2	-

 119,700 lb  165,600 lb  211,400 lb  257,300 lb

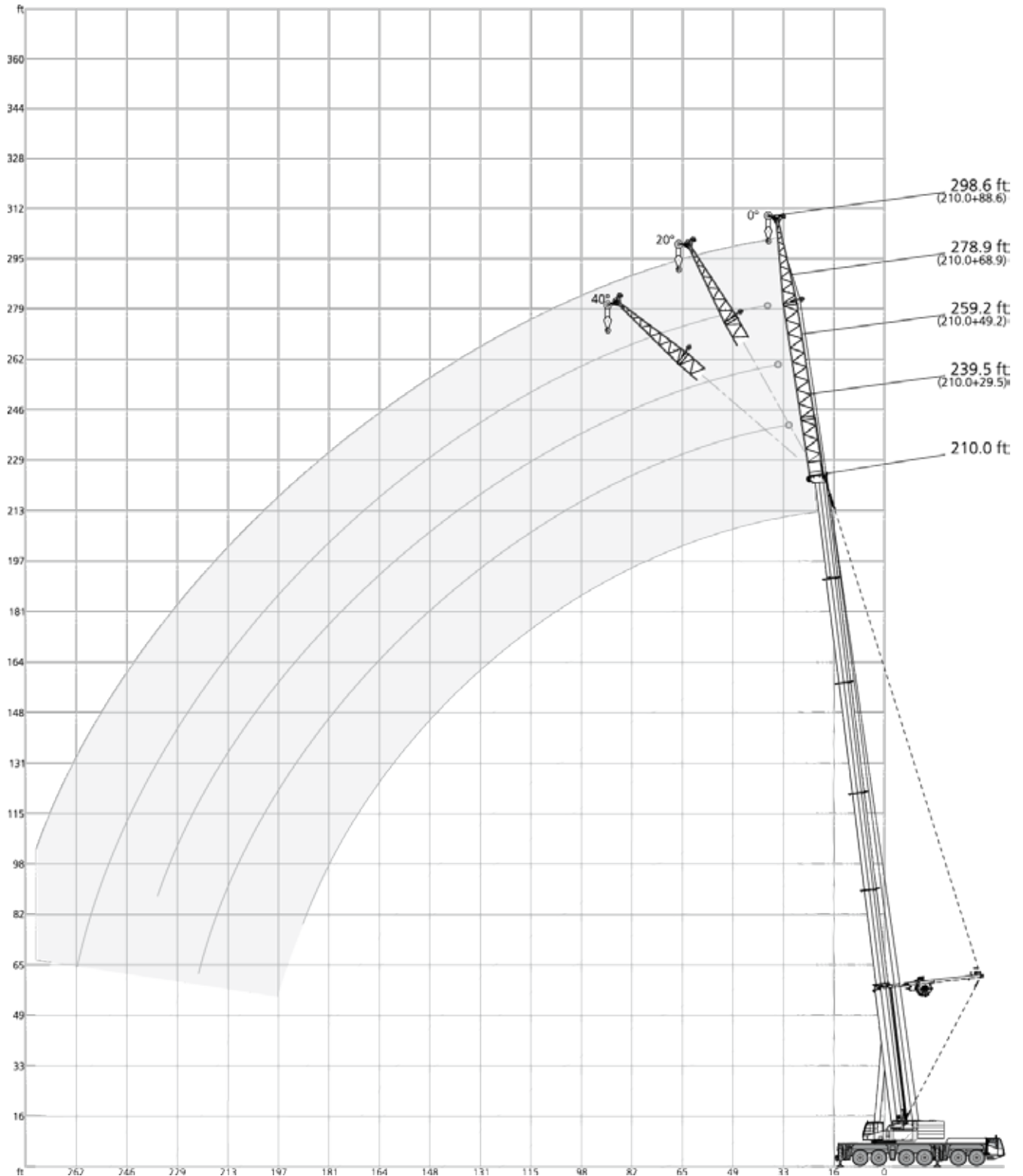
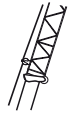

28.5 ft x 27.9 ft										360°										85%									
44.9 ft										118.8 ft																			
ft	29.5 ft	49.2 ft*			68.9 ft			88.6 ft*			ft	29.5 ft	49.2 ft*			68.9 ft			88.6 ft*										
		0°	0°	20°	40°	0°	0°	20°	40°	0°			0°	20°	40°	0°	0°	20°	40°										
1,000 lb										1,000 lb																			
10	100.0	-	-	-	-	-	-	-	-	24	93.4	-	-	-	-	-	-	-	-										
12	98.9	-	-	-	-	-	-	-	-	28	83.7	-	-	-	-	-	-	-	-										
14	94.4	97.0	-	-	-	-	-	-	-	32	75.7	74.0	-	-	-	-	-	-	-										
16	85.7	93.4	-	-	-	-	-	-	-	36	69.3	69.1	-	-	-	52.8	-	-	-										
18	78.5	88.3	-	-	72.3	-	-	-	-	40	63.3	64.3	-	-	49.9	42.0	-	-	-										
20	71.9	82.8	-	-	68.2	59.5	-	-	-	48	55.4	56.2	35.6	-	45.1	37.7	-	-	-										
24	61.4	71.5	-	-	61.1	53.7	-	-	-	56	48.0	50.3	32.9	-	41.1	34.2	-	-	-										
28	52.2	63.6	-	-	55.2	48.6	-	-	-	64	42.5	45.0	30.6	23.1	37.9	31.4	-	-	-										
32	46.4	56.4	39.0	-	50.6	44.3	-	-	-	72	38.7	40.2	28.5	22.1	34.9	29.1	19.0	-	-										
36	41.4	50.6	36.1	-	46.9	40.9	-	-	-	80	34.7	37.3	26.7	21.3	32.1	26.8	18.0	-	-										
40	36.8	45.5	33.4	-	43.3	37.7	-	-	-	88	31.4	34.5	25.3	20.5	30.2	24.7	17.1	11.4	-										
48	30.8	38.5	29.3	23.7	37.3	32.7	-	-	-	96	29.1	31.5	24.0	20.0	28.5	23.1	16.1	11.0	-										
56	26.1	32.6	26.0	21.8	33.3	28.6	20.9	-	-	104	27.0	29.3	22.9	19.6	26.7	21.8	15.3	10.6	-										
64	22.7	28.9	23.4	20.2	29.3	25.7	18.9	-	-	112	25.1	27.5	22.0	19.2	24.9	20.4	14.5	10.3	-										
72	-	25.4	21.4	19.2	26.5	23.0	17.2	-	-	120	23.7	25.9	21.1	18.9	23.8	19.1	14.0	9.9	-										
80	-	23.0	-	-	24.3	20.5	15.9	11.6	-	128	22.4	24.4	20.3	-	22.7	18.0	13.4	9.6	-										
88	-	-	-	-	22.2	19.1	14.8	10.8	-	136	21.2	23.2	19.7	-	21.6	17.2	12.9	9.3	-										
96	-	-	-	-	20.7	17.5	13.7	10.3	-	144	15.7	22.1	19.2	-	20.7	16.4	12.5	9.2	-										
104	-	-	-	-	19.3	16.1	12.8	9.9	-	152	-	21.1	-	-	19.8	15.5	12.1	9.0	-										
112	-	-	-	-	-	14.9	11.9	-	-	160	-	12.1	-	-	19.1	14.7	11.7	8.8	-										
120	-	-	-	-	-	14.0	-	-	-	168	-	-	-	-	18.5	14.1	11.4	-	-										
										176	-	-	-	-	17.9	13.7	11.3	-	-										
										184	-	-	-	-	-	13.3	7.7	-	-										
										192	-	-	-	-	-	12.9	-	-	-										
										200	-	-	-	-	-	6.6	-	-	-										

133.5 ft										
ft	29.5 ft	49.2 ft*			68.9 ft			88.6 ft*		
		0°	0°	20°	40°	0°	0°	20°	40°	
1,000 lb										
28	84.7	-	-	-	-	-	-	-	-	
32	77.3	-	-	-	-	-	-	-	-	
36	71.3	69.3	-	-	-	-	-	-	-	
40	65.8	65.6	-	-	49.4	41.2	-	-	-	
48	56.8	58.3	36.1	-	44.9	37.5	-	-	-	
56	50.8	52.0	33.6	-	41.1	34.2	-	-	-	
64	44.8	47.4	31.3	23.3	38.0	31.4	-	-	-	
72	40.4	42.9	29.4	22.5	35.5	29.1	-	-	-	
80	37.2	38.8	27.7	21.7	33.1	27.3	18.1	-	-	
88	34.0	36.2	26.2	21.0	30.7	25.4	17.1	-	-	
96	31.0	33.8	25.0	20.3	28.9	23.5	16.3	11.0	-	
104	29.0	31.4	23.8	19.8	27.4	22.2	15.6	10.6	-	
112	27.2	29.0	22.7	19.4	25.9	21.1	15.0	10.3	-	
120	25.3	27.5	21.9	19.1	24.5	19.9	14.3	9.9	-	
128	23.8	26.1	21.0	18.8	23.2	18.7	13.7	9.6	-	
136	22.7	24.6	20.2	-	22.3	17.7	13.1	9.5	-	
144	21.7	23.4	19.7	-	21.3	16.9	12.7	9.3	-	
152	-	22.4	19.4	-	20.4	16.2	12.3	9.0	-	
160	-	21.6	19.0	-	19.6	15.6	12.0	8.9	-	
168	-	20.1	-	-	19.0	14.9	11.7	8.8	-	
176	-	-	-	-	18.6	14.2	11.3	-	-	
184	-	-	-	-	17.3	13.8	11.1	-	-	
192	-	-	-	-	-	13.4	11.0	-	-	
200	-	-	-	-	-	13.0	10.8	-	-	
208	-	-	-	-	-	12.5	-	-	-	

148.3 ft										
ft	29.5 ft	49.2 ft*			68.9 ft			88.6 ft*		
		0°	0°	20°	40°	0°	0°	20°	40°	
1,000 lb										
36	70.8	-	-	-	-	-	-	-	-	
40	65.5	63.4	-	-	46.2	-	-	-	-	
48	57.8	57.5	-	-	42.7	36.3	-	-	-	
56	51.5	52.0	33.7	-	39.6	33.4	-	-	-	
64	46.6	47.3	31.5	-	36.8	31.1	-	-	-	
72	42.0	43.7	29.6	22.5	34.4	28.7	-	-	-	
80	38.2	40.0	28.2	21.7	32.3	27.1	18.1	-	-	
88	35.7	36.9	26.7	21.0	30.5	25.5	17.1	-	-	
96	33.0	34.6	25.3	20.4	28.6	23.9	16.3	-	-	
104	30.6	32.5	24.3	20.0	27.2	22.4	15.6	10.6	-	
112	28.4	30.5	23.3	19.6	25.9	21.1	15.0	10.3	-	
120	26.9	28.7	22.4	19.2	24.6	20.2	14.3	10.1	-	
128	25.4	27.1	21.6	18.9	23.4	19.2	13.7	9.8	-	
136	23.9	25.8	21.1	18.8	22.3	18.3	13.3	9.5	-	
144	22.9	24.6	20.4	18.5	21.4	17.3	12.9	9.3	-	
152	21.9	23.4	19.8	-	20.6	16.4	12.5	9.0	-	
160	21.1	22.4	19.4	-	20.0	15.8	12.1	8.9	-	
168	-	21.3	19.1	-	19.2	15.2	11.8	8.8	-	
176	-	20.2	19.0	-	18.4	14.6	11.5	8.6	-	
184	-	-	-	-	17.7	14.1	11.2	-	-	
192	-	-	-	-	16.6	13.6	11.0	-	-	
200	-	-	-	-	14.9	13.3	11.0	-	-	
208	-	-	-	-	-	13.0	10.9	-	-	
216	-	-	-	-	-	12.6	10.8	-	-	

32,000lb 39,900lb 54,200lb 76,500lb 98,800lb 119,700lb 165,600lb 211,400lb 257,300lb

* LF-A

28.5 ft x 27.9 ft										360°										85%									
163.1 ft										177.8 ft																			
ft	29.5 ft	49.2 ft*			68.9 ft			88.6 ft*			ft	29.5 ft	49.2 ft*			68.9 ft			88.6 ft*										
		0°	0°	20°	40°	0°	0°	20°	40°	0°			0°	20°	40°	0°	0°	20°	40°										
1,000 lb										1,000 lb																			
40	64.9	-	-	-	-	-	-	-	-	40	60.4	-	-	-	-	-	-	-	-										
48	57.6	55.0	-	-	40.3	-	-	-	-	48	54.9	50.9	-	-	-	-	-	-	-										
56	51.6	50.5	-	-	37.7	32.1	-	-	-	56	50.1	47.4	-	-	35.1	-	-	-	-										
64	47.1	46.3	31.5	-	35.5	30.0	-	-	-	64	45.8	44.2	-	-	33.2	28.1	-	-	-										
72	43.3	42.8	29.8	22.5	33.1	28.0	-	-	-	72	42.4	41.3	29.4	-	31.6	26.5	-	-	-										
80	39.5	40.1	28.2	21.7	31.5	26.2	18.0	-	-	80	39.7	38.7	28.0	21.7	29.9	25.1	-	-	-										
88	36.4	37.4	27.0	21.2	29.9	24.9	17.1	-	-	88	36.7	36.5	26.8	21.0	28.5	23.8	16.7	-	-										
96	34.4	34.7	25.8	20.7	28.3	23.6	16.3	-	-	96	34.2	34.5	25.7	20.6	27.3	22.7	15.9	-	-										
104	32.2	32.8	24.7	20.1	26.8	22.3	15.6	10.6	-	104	32.3	32.5	24.7	20.2	26.1	21.7	15.3	-	-										
112	30.1	31.2	23.8	19.6	25.5	21.1	15.0	10.1	-	112	30.6	30.6	23.8	19.8	24.9	20.7	14.7	10.1	-										
120	28.2	29.5	22.8	19.3	24.4	20.0	14.4	9.9	-	120	28.9	29.1	23.0	19.4	23.8	19.7	14.2	9.9	-										
128	26.6	27.8	22.0	19.1	23.4	19.1	13.9	9.6	-	128	27.4	27.6	22.2	19.1	22.8	18.8	13.7	9.6	-										
136	25.4	26.3	21.3	18.8	22.5	18.3	13.3	9.5	-	136	25.9	26.1	21.5	18.8	22.0	18.0	13.3	9.3	-										
144	24.2	25.0	20.7	18.7	21.5	17.5	12.9	9.3	-	144	24.8	24.6	20.9	18.6	21.1	17.3	12.9	9.2	-										
152	23.0	23.6	20.2	18.5	20.6	16.7	12.5	9.0	-	152	23.9	23.2	20.2	18.5	20.2	16.7	12.5	9.0	-										
160	21.9	22.3	19.7	-	20.0	16.0	12.1	8.9	-	160	22.8	21.8	19.8	18.5	19.4	16.0	12.1	8.9	-										
168	20.8	21.0	19.1	-	19.2	15.4	11.8	8.8	-	168	21.6	20.4	19.4	18.5	18.6	15.4	11.8	8.8	-										
176	19.6	19.8	18.4	-	18.4	14.8	11.5	8.6	-	176	20.3	19.0	18.8	-	17.8	14.8	11.5	8.6	-										
184	-	18.5	17.8	-	17.7	14.4	11.3	8.6	-	184	18.8	17.7	17.9	-	16.8	14.3	11.3	8.5	-										
192	-	16.5	-	-	17.0	14.0	11.2	8.5	-	192	16.4	16.6	16.9	-	15.9	13.8	11.2	8.4	-										
200	-	12.7	-	-	15.9	13.5	10.9	-	-	200	-	15.6	15.6	-	15.1	13.2	10.9	8.4	-										
208	-	-	-	-	13.9	12.9	10.8	-	-	208	-	12.6	-	-	14.3	12.7	10.7	-	-										
216	-	-	-	-	12.6	12.4	10.8	-	-	216	-	10.2	-	-	13.5	12.2	10.6	-	-										
224	-	-	-	-	-	11.8	10.8	-	-	232	-	-	-	-	-	10.9	10.3	-	-										
240	-	-	-	-	-	7.5	-	-	-	248	-	-	-	-	-	7.5	-	-	-										

192.6 ft										210.0 ft											
ft	29.5 ft	49.2 ft*			68.9 ft			88.6 ft*			ft	29.5 ft	49.2 ft*			68.9 ft			88.6 ft*		
		0°	0°	20°	40°	0°	0°	20°	40°	0°			0°	20°	40° ¹⁾						
1,000 lb										1,000 lb											
48	51.0	-	-	-	-	-	-	-	-	56	41.8	-	-	-	-	-	-	-	-		
56	47.2	41.7	-	-	-	-	-	-	-	64	38.7	32.6	-	-	-	-	-	-	-		
64	43.9	38.9	-	-	30.3	-	-	-	-	72	36.2	30.7	-	-	25.1	20.1	-	-	-		
72	40.6	36.4	-	-	29.1	24.5	-	-	-	80	33.6	28.8	26.0	-	24.5	20.1	-	-	-		
80	38.2	34.1	27.4	21.5	27.8	23.4	-	-	-	88	31.6	26.7	24.5	20.8	23.0	19.8	-	-	-		
88	36.1	32.0	26.3	21.0	26.7	22.3	-	-	-	96	29.8	25.1	23.1	20.2	21.6	18.8	-	-	-		
96	33.9	30.3	25.2	20.4	25.5	21.4	15.6	-	-	104	28.0	23.8	21.9	19.8	20.4	17.9	14.5	-	-		
104	32.1	28.5	24.4	20.0	24.2	20.5	15.0	-	-	112	26.2	22.4	20.7	19.4	19.3	16.9	14.1	-	-		
112	30.3	26.6	23.5	19.6	22.9	19.6	14.3	9.9	-	120	25.0	21.1	19.7	18.7	18.3	16.0	13.5	9.6	-		
120	29.0	25.3	22.7	19.3	21.7	18.8	13.9	9.7	-	128	23.7	19.9	18.7	18.0	17.2	15.1	13.1	9.4	-		
128	27.7	24.0	21.9	19.1	20.6	18.0	13.5	9.6	-	136	22.5	19.0	17.7	17.2	16.3	14.3	12.7	9.3	-		
136	26.3	22.9	21.1	18.8	19.6	17.2	13.1	9.3	-	144	21.4	18.0	16.9	16.5	15.6	13.5	12.1	9.1	-		
144	25.0	21.8	20.3	18.6	18.8	16.4	12.7	9.2	-	152	20.4	17.1	16.2	15.8	14.9	12.7	11.6	8.8	-		
152	23.6	20.6	19.5	18.5	18.0	15.6	12.3	9.0	-	160	19.3	16.3	15.4	15.3	14.1	12.0	11.1	8.7	-		
160	22.4	19.7	18.9	18.2	17.0	14.9	12.0	8.7	-	168	18.3	15.5	14.7	14.6	13.3	11.4	10.6	8.5	-		
168	21.2	18.7	18.2	17.8	16.2	14.2	11.8	8.5	-	176	17.5	14.7	14.2	14.1	12.7	10.9	10.2	8.4	-		
176	19.8	17.8	17.5	17.5	15.5	13.5	11.5	8.4	-	184	16.7	14.1	13.7	13.7	12.1	10.3	9.8	8.4	-		
184	18.5	16.8	16.7	-	15.0	12.9	11.2	8.4	-	192	15.7	13.6	13.1	13.1	11.6	9.8	9.4	8.3	-		
192	17.4	15.9	15.9	-	14.4	12.2	11.0	8.4	-	200	14.9	13.0	12.6	-	11.0	9.3	8.8	8.2	-		
200	15.6	15.0	15.1	-	13.7	11.7	10.7	8.4	-	208	13.9	12.4	12.0	-	10.6	8.8	8.4	8.1	-		
208	11.9	14.1	14.2	-	13.1	11.2	10.4	8.4	-	216	12.9	11.7	11.5	-	10.2	8.4	8.2	7.9	-		
216	-	13.3	13.3	-	12.6	10.8	10.2	8.4	-	224	8.8	11.1	11.0	-	9.9	8.1	7.8	7.7	-		
224	-	9.8	-	-	12.1	10.4	9.9	-	-	232	-	10.0	10.4	-	9.4	7.8	7.4	-	-		
232	-	-	-	-	11.2	10.0	9.6	-	-	240	-	7.8	-	-	9.0	7.4	7.1	-	-		
240	-	-	-	-	9.6	9.4	9.4	-	-	248	-	-	-	-	8.5	7.0	6.9	-	-		
248	-	-	-	-	-	8.9	9.0	-	-	256	-	-	-	-	7.9	6.6	6.6	-	-		
264	-	-	-	-	-	5.3	-	-	-	272	-	-	-	-	-	5.7	6.3	-	-		

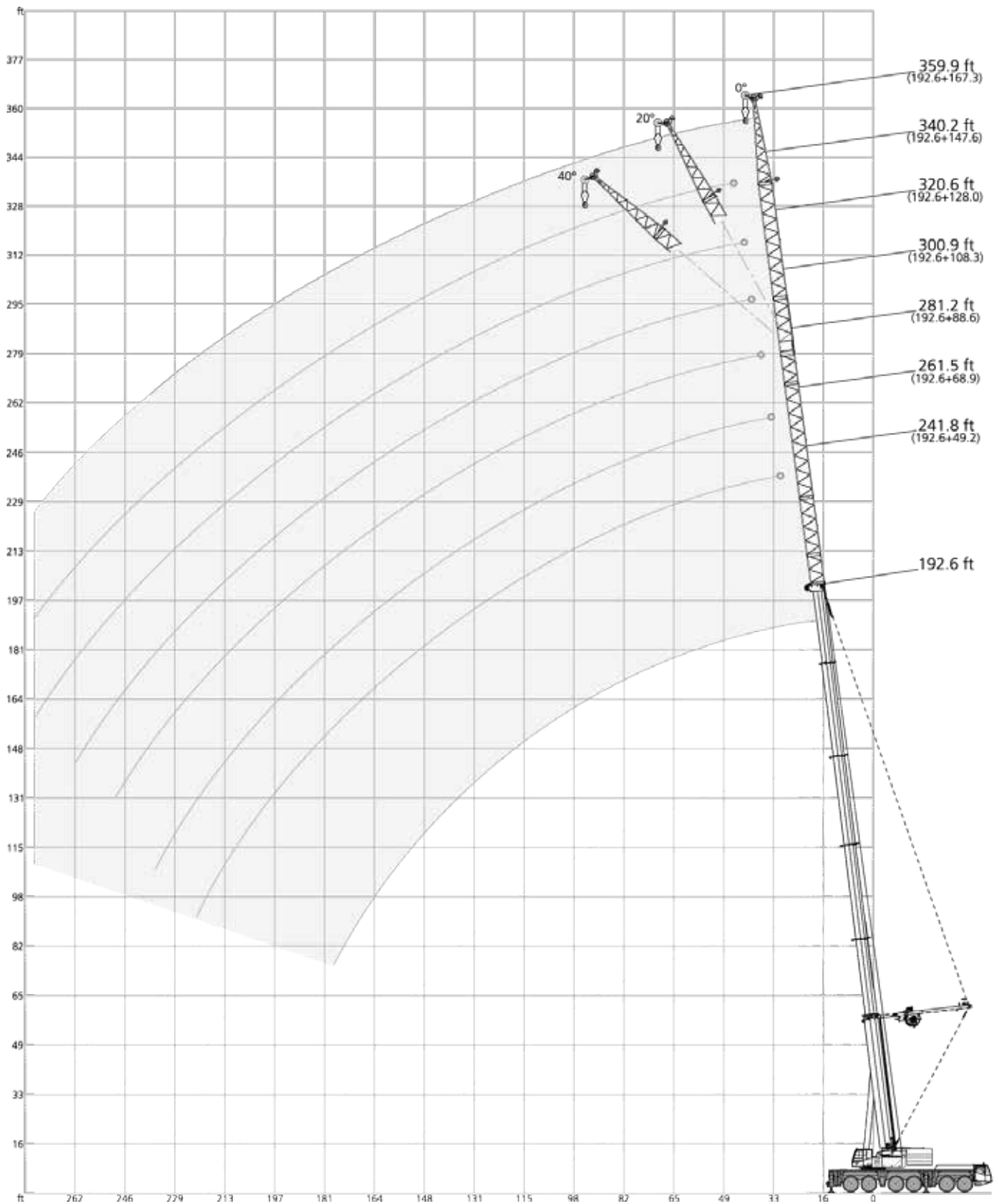

28.5 ft x 27.9 ft													360°			85%			
44.9 ft																			
ft	49.2 ft		68.9 ft*			88.6 ft*			108.3 ft*			128.0 ft		147.6 ft		167.3 ft*			ft
	0°	0°	20°	40°	0°	20°	40°	0°	20°	40°	0°	0°	0°	20°	40°	0°	20°	40°	
1,000 lb																			
14	98.2	-	-	-	-	-	-	-	-	-	-	-	-	-	-	-	-	-	14
16	96.4	-	-	-	-	-	-	-	-	-	-	-	-	-	-	-	-	-	16
18	91.2	94.4	-	-	-	-	-	-	-	-	-	-	-	-	-	-	-	-	18
20	84.8	89.4	-	-	-	-	-	-	-	-	-	-	-	-	-	-	-	-	20
24	71.9	79.7	-	-	81.3	-	-	-	-	-	-	-	-	-	-	-	-	-	24
28	63.9	70.4	-	-	73.3	-	-	63.9	-	-	-	-	-	-	-	-	-	-	28
32	56.2	63.3	-	-	66.6	-	-	58.2	-	-	51.7	-	-	-	-	-	-	-	32
36	50.5	57.9	38.2	-	61.0	-	-	53.8	-	-	48.0	43.4	-	-	-	-	-	-	36
40	45.5	52.6	35.6	-	55.8	37.2	-	49.7	-	-	44.5	40.4	35.8	-	-	-	-	-	40
48	38.2	44.2	31.6	24.4	48.0	33.6	-	43.1	34.7	-	39.0	35.5	31.4	-	-	-	-	-	48
56	32.5	38.9	28.5	22.8	41.4	30.6	23.4	37.6	31.8	23.7	34.5	31.3	27.9	-	-	-	-	-	56
64	28.6	33.7	26.0	21.4	37.0	28.0	22.3	32.7	29.3	22.7	30.6	27.9	24.8	-	-	-	-	-	64
72	25.2	30.1	23.9	20.3	32.7	26.1	21.2	29.6	27.2	21.6	26.8	25.0	22.5	-	-	-	-	-	72
80	22.8	27.1	22.2	19.5	29.2	24.2	20.4	26.7	24.8	20.8	24.6	22.1	20.2	17.9	-	-	-	-	80
88	-	24.6	20.7	-	26.7	22.6	19.7	23.8	22.6	20.1	22.4	20.0	18.0	16.8	-	-	-	-	88
96	-	22.8	19.6	-	24.3	21.4	19.1	21.7	20.8	19.6	20.1	18.3	16.3	15.6	11.0	-	-	-	96
104	-	21.0	-	-	22.5	20.4	-	20.0	19.3	18.7	18.4	16.7	15.0	14.4	10.6	-	-	-	104
112	-	-	-	-	20.9	-	-	18.4	17.8	-	16.9	15.1	13.8	13.2	10.3	-	-	-	112
120	-	-	-	-	19.5	-	-	17.1	16.6	-	15.7	13.9	12.5	12.2	10.1	-	-	-	120
128	-	-	-	-	-	-	-	15.9	15.4	-	14.5	12.9	11.3	11.3	9.8	-	-	-	128
136	-	-	-	-	-	-	-	14.8	-	-	13.5	12.1	10.4	10.4	9.5	-	-	-	136
144	-	-	-	-	-	-	-	13.9	-	-	12.7	11.2	9.6	9.6	9.3	-	-	-	144
160	-	-	-	-	-	-	-	-	-	-	-	9.6	8.3	8.3	8.3	-	-	-	160
176	-	-	-	-	-	-	-	-	-	-	-	8.5	7.1	7.1	7.1	-	-	-	176
192	-	-	-	-	-	-	-	-	-	-	-	-	6.3	-	-	-	-	-	192

118.8 ft																			
ft	49.2 ft		68.9 ft*			88.6 ft*			108.3 ft*			128.0 ft		147.6 ft		167.3 ft*			ft
	0°	0°	20°	40°	0°	20°	40°	0°	20°	40°	0°	0°	0°	20°	40°	0°	20°	40°	
1,000 lb																			
32	76.5	-	-	-	-	-	-	-	-	-	-	-	-	-	-	-	-	-	32
36	70.8	67.7	-	-	-	-	-	-	-	-	-	-	-	-	-	-	-	-	36
40	65.4	64.1	-	-	54.8	-	-	-	-	-	-	-	-	-	-	-	-	-	40
48	56.8	57.4	-	-	48.9	-	-	42.3	-	-	37.2	-	-	-	-	-	-	-	48
56	50.9	51.6	33.6	-	44.0	33.8	-	38.0	-	-	33.7	29.8	-	-	-	-	-	-	56
64	45.2	46.9	31.3	23.3	39.8	31.7	-	34.4	30.6	-	30.7	27.0	23.8	-	-	-	-	-	64
72	40.4	42.6	29.4	22.5	36.4	29.8	22.5	31.4	28.1	-	28.1	24.7	21.7	-	-	-	-	-	72
80	37.5	38.6	27.7	21.7	33.4	28.2	21.7	28.9	25.9	21.7	25.7	22.6	19.8	-	-	-	-	-	80
88	34.5	35.8	26.2	21.0	30.4	26.6	21.2	26.6	24.0	21.2	23.9	20.9	18.2	-	-	-	-	-	88
96	31.4	33.4	25.0	20.3	28.1	25.1	20.7	24.3	22.5	20.5	22.2	19.4	16.7	15.3	-	-	-	-	96
104	29.2	31.0	23.9	19.8	26.3	23.8	20.1	22.6	21.0	19.6	20.4	18.0	15.6	14.2	-	-	-	-	104
112	27.5	28.8	22.9	19.4	24.6	22.4	19.6	21.1	19.6	18.7	18.7	16.7	14.5	13.2	10.3	-	-	-	112
120	25.7	27.2	22.1	19.1	22.7	21.1	19.3	19.7	18.5	17.7	17.6	15.5	13.3	12.4	10.1	-	-	-	120
128	24.2	25.6	21.3	18.8	21.2	19.8	18.9	18.4	17.4	16.8	16.5	14.4	12.2	11.6	9.8	-	-	-	128
136	23.0	24.1	20.5	18.6	20.1	18.8	18.2	17.1	16.3	15.9	15.5	13.4	11.4	10.8	9.5	-	-	-	136
144	22.0	22.8	19.9	-	19.0	17.9	17.5	16.0	15.5	15.0	14.4	12.6	10.7	10.0	9.2	-	-	-	144
152	21.0	21.5	19.4	-	17.9	17.1	9.3	15.1	14.7	14.3	13.4	11.8	10.1	9.2	8.8	-	-	-	152
160	11.4	20.7	19.1	-	16.9	16.3	-	14.4	13.9	13.6	12.7	11.0	9.4	8.6	8.5	-	-	-	160
168	-	19.9	9.0	-	16.0	15.6	-	13.7	13.1	6.9	12.1	10.2	8.6	8.1	8.1	-	-	-	168
176	-	17.5	-	-	15.5	15.1	-	12.9	12.4	-	11.5	9.6	7.8	7.6	7.6	-	-	-	176
184	-	-	-	-	14.9	6.6	-	12.2	11.9	-	10.9	9.0	7.4	7.2	7.2	-	-	-	184
192	-	-	-	-	14.0	-	-	11.6	11.4	-	10.2	8.7	7.0	6.7	6.7	-	-	-	192
200	-	-	-	-	5.5	-	-	11.2	11.0	-	9.7	8.2	6.6	6.3	6.3	-	-	-	200
208	-	-	-	-	-	-	-	10.7	4.1	-	9.3	7.6	6.1	6.0	6.0	-	-	-	208
216	-	-	-	-	-	-	-	10.4	-	-	9.1	7.1	5.7	5.5	5.5	-	-	-	216
232	-	-	-	-	-	-	-	-	-	-	-	6.5	5.0	5.0	-	-	-	-	232
248	-	-	-	-	-	-	-	-	-	-	-	6.0	4.5	4.5	-	-	-	-	248
264	-	-	-	-	-	-	-	-	-	-	-	-	4.1	-	-	-	-	-	264

28.5 ft x 27.9 ft																360°	85%
133.5 ft																	
ft	49.2 ft	68.9 ft*			88.6 ft*			108.3 ft*			128.0 ft	147.6 ft	167.3 ft*			ft	
		0°	0°	20°	40°	0°	20°	40°	0°	20°	40°	0°	0°	0°	20°		40°
1,000 lb																	
36	70.8	-	-	-	-	-	-	-	-	-	-	-	-	-	-	36	
40	65.7	62.6	-	-	-	-	-	-	-	-	-	-	-	-	-	40	
48	58.1	56.9	-	-	48.3	-	-	41.4	-	-	-	-	-	-	-	48	
56	51.8	51.8	33.9	-	43.8	-	-	37.6	-	-	33.2	-	-	-	-	56	
64	47.0	47.2	31.9	-	40.0	31.9	-	34.5	-	-	30.4	26.7	-	-	-	64	
72	42.4	43.5	30.0	22.5	36.7	30.2	-	31.6	28.3	-	28.0	24.5	21.4	-	-	72	
80	38.6	40.0	28.4	21.9	34.0	28.6	22.0	29.0	26.2	22.0	25.7	22.6	19.6	-	-	80	
88	36.0	36.8	26.9	21.2	31.4	27.1	21.3	27.1	24.3	21.4	23.9	20.8	18.3	-	-	88	
96	33.4	34.4	25.5	20.7	28.8	25.8	20.8	25.1	22.7	20.9	22.5	19.4	16.8	15.3	-	96	
104	31.0	32.3	24.5	20.1	27.0	24.3	20.3	23.3	21.3	20.1	20.9	18.1	15.7	14.3	-	104	
112	28.8	30.3	23.5	19.6	25.5	22.9	19.8	21.5	20.0	19.1	19.3	16.9	14.7	13.4	10.1	112	
120	27.3	28.3	22.6	19.3	23.9	21.8	19.4	20.3	18.8	18.0	18.1	15.7	13.6	12.5	10.1	120	
128	25.8	26.6	21.8	19.1	22.3	20.7	19.0	19.1	17.7	17.1	17.0	14.6	12.6	11.6	9.8	128	
136	24.4	25.2	21.1	18.8	20.8	19.6	18.6	17.9	16.7	16.3	16.1	13.7	11.7	11.0	9.5	136	
144	23.2	24.0	20.5	18.5	19.8	18.7	18.0	16.8	15.8	15.5	15.1	12.9	10.9	10.3	9.3	144	
152	22.2	22.8	20.0	-	18.8	17.8	17.3	15.8	14.9	14.7	14.2	12.2	10.3	9.6	9.0	152	
160	21.4	21.7	19.5	-	17.9	17.1	16.7	15.0	14.4	14.2	13.3	11.4	9.6	8.9	8.6	160	
168	19.4	20.8	18.9	-	17.0	16.4	-	14.2	13.8	13.6	12.5	10.7	9.0	8.4	8.2	168	
176	-	20.0	18.4	-	16.2	15.8	-	13.5	13.1	13.1	12.0	10.0	8.5	8.0	7.8	176	
184	-	16.6	-	-	15.6	15.2	-	12.9	12.5	-	11.4	9.5	7.7	7.5	7.4	184	
192	-	-	-	-	15.1	14.7	-	12.3	12.0	-	10.9	9.0	7.2	7.0	7.0	192	
200	-	-	-	-	14.5	-	-	11.9	11.6	-	10.4	8.5	6.8	6.6	6.6	200	
216	-	-	-	-	-	-	-	11.1	10.8	-	9.3	7.7	6.0	6.0	6.0	216	
232	-	-	-	-	-	-	-	-	-	-	8.7	6.8	5.4	5.2	-	232	
248	-	-	-	-	-	-	-	-	-	-	-	6.4	4.7	4.7	-	248	
264	-	-	-	-	-	-	-	-	-	-	-	5.4	4.3	4.1	-	264	
280	-	-	-	-	-	-	-	-	-	-	-	-	3.8	-	-	280	

148.3 ft																
ft	49.2 ft	68.9 ft*			88.6 ft*			108.3 ft*			128.0 ft	147.6 ft	167.3 ft*			ft
		0°	0°	20°	40°	0°	20°	40°	0°	20°	40°	0°	0°	0°	20°	
1,000 lb																
40	65.5	-	-	-	-	-	-	-	-	-	-	-	-	-	-	40
48	58.2	54.8	-	-	46.2	-	-	-	-	-	-	-	-	-	-	48
56	52.4	50.5	-	-	42.4	-	-	36.4	-	-	-	-	-	-	-	56
64	47.8	46.5	31.7	-	39.2	-	-	33.4	-	-	29.4	-	-	-	-	64
72	44.0	43.1	30.0	-	36.2	30.0	-	31.1	-	-	27.2	23.9	-	-	-	72
80	40.2	40.1	28.4	21.9	33.6	28.7	22.0	28.8	26.0	21.9	25.3	22.1	19.0	-	-	80
88	37.1	37.5	27.2	21.2	31.5	27.3	21.4	26.8	24.4	21.2	23.6	20.6	17.7	-	-	88
96	34.8	34.8	26.0	20.7	29.5	26.0	20.9	25.2	22.8	20.7	22.0	19.1	16.5	-	-	96
104	32.7	32.7	24.8	20.2	27.5	24.6	20.4	23.6	21.4	19.9	20.8	18.0	15.3	14.0	-	104
112	30.5	31.0	23.8	19.8	25.5	23.3	20.0	22.0	20.2	19.1	19.6	16.9	14.3	13.0	-	112
120	28.7	29.2	23.0	19.4	24.3	22.1	19.5	20.6	19.1	18.2	18.3	15.8	13.5	12.3	9.9	120
128	27.1	27.5	22.2	19.1	23.0	21.0	19.0	19.5	18.1	17.3	17.2	14.8	12.7	11.6	9.6	128
136	25.8	25.9	21.3	18.8	21.7	20.1	18.6	18.5	17.2	16.5	16.3	13.9	11.9	10.8	9.5	136
144	24.6	24.5	20.9	18.3	20.4	19.1	18.2	17.5	16.4	15.8	15.5	13.1	11.0	10.2	9.4	144
152	23.4	23.2	20.4	17.8	19.3	18.2	17.8	16.4	15.5	15.1	14.7	12.5	10.1	9.6	9.2	152
160	22.2	22.0	19.9	-	18.5	17.5	17.2	15.5	14.7	14.4	13.9	11.8	9.7	9.1	8.8	160
168	21.0	20.7	19.3	-	17.7	16.9	16.6	14.7	14.1	13.8	13.0	11.1	9.2	8.6	8.3	168
176	19.8	19.4	18.6	-	17.1	16.2	-	14.0	13.5	13.3	12.2	10.5	8.7	8.0	7.8	176
184	-	18.1	17.7	-	16.3	15.5	-	13.4	13.0	12.8	11.7	9.8	8.1	7.6	7.4	184
192	-	16.4	-	-	15.5	14.9	-	12.9	12.5	-	11.2	9.2	7.6	7.2	7.0	192
200	-	13.0	-	-	14.5	14.3	-	12.4	11.9	-	10.8	8.8	7.1	6.8	6.7	200
208	-	-	-	-	13.2	13.6	-	11.7	11.5	-	10.3	8.4	6.6	6.4	6.4	208
216	-	-	-	-	11.9	-	-	11.1	11.3	-	9.7	8.0	6.2	6.0	6.0	216
224	-	-	-	-	-	-	-	10.6	10.9	-	9.3	7.6	5.9	5.7	5.7	224
240	-	-	-	-	-	-	-	7.1	-	-	8.7	6.8	5.2	5.2	5.2	240
256	-	-	-	-	-	-	-	-	-	-	-	6.4	4.6	4.6	-	256
272	-	-	-	-	-	-	-	-	-	-	-	5.2	4.1	4.1	-	272
288	-	-	-	-	-	-	-	-	-	-	-	-	3.8	3.8	-	288



* SF-A  76,500 lb 98,800 lb 119,700 lb 165,600 lb 211,400 lb 257,300 lb

28.5 ft x 27.9 ft													360°			85%		
163.1 ft																		
ft	49.2 ft	68.9 ft*			88.6 ft*			108.3 ft*			128.0 ft	147.6 ft	167.3 ft*			ft		
		0°	0°	20°	40°	0°	20°	40°	0°	20°	40°	0°	0°	0°	20°		40°	
1,000 lb																		
48	55.9	-	-	-	-	-	-	-	-	-	-	-	-	-	-	48		
56	51.0	47.6	-	-	40.0	-	-	-	-	-	-	-	-	-	-	56		
64	46.7	44.5	-	-	37.2	-	-	31.7	-	-	-	-	-	-	-	64		
72	43.3	41.5	29.8	-	34.9	-	-	29.6	-	-	25.8	-	-	-	-	72		
80	40.3	38.9	28.4	21.7	32.5	28.2	21.9	27.7	25.1	-	24.2	21.0	17.9	-	-	80		
88	37.5	36.8	27.1	21.2	30.5	26.9	21.2	26.0	23.7	21.2	22.7	19.7	16.8	-	-	88		
96	34.8	34.6	26.0	20.7	28.9	25.5	20.8	24.4	22.4	20.7	21.4	18.5	15.8	-	-	96		
104	32.8	32.5	25.0	20.2	27.3	24.4	20.3	23.1	21.2	19.8	20.2	17.3	14.8	-	-	104		
112	31.2	30.5	24.0	19.8	25.7	23.3	19.8	21.8	20.0	18.9	19.1	16.3	13.8	12.7	-	112		
120	29.5	28.8	23.2	19.4	24.2	22.1	19.6	20.5	19.1	18.1	18.2	15.5	13.0	11.9	-	120		
128	27.8	27.1	22.4	19.1	22.9	21.0	19.2	19.4	18.1	17.3	17.2	14.7	12.3	11.2	9.5	128		
136	26.2	25.5	21.8	19.0	21.8	20.1	18.8	18.3	17.2	16.5	16.1	13.8	11.6	10.7	9.3	136		
144	24.8	23.9	21.1	18.6	20.9	19.2	18.3	17.5	16.5	15.8	15.4	13.0	10.9	10.1	9.1	144		
152	23.4	22.3	20.4	18.2	19.9	18.4	17.8	16.6	15.8	15.1	14.7	12.3	10.3	9.4	8.8	152		
160	21.9	20.8	19.6	17.4	18.8	17.6	17.2	15.8	15.0	14.6	14.0	11.6	9.6	9.0	8.5	160		
168	20.5	19.4	18.8	16.6	17.8	16.9	16.7	15.0	14.2	14.1	13.3	11.0	9.0	8.6	8.2	168		
176	19.2	18.1	18.0	-	16.7	16.2	16.2	14.2	13.5	13.5	12.7	10.4	8.5	8.0	7.8	176		
184	18.0	16.8	17.1	-	15.7	15.5	-	13.5	13.1	13.0	12.0	10.0	8.1	7.6	7.4	184		
192	15.6	15.6	16.1	-	14.8	14.8	-	12.9	12.7	12.7	11.4	9.6	7.6	7.2	7.0	192		
200	11.0	14.6	14.8	-	13.7	14.0	-	12.4	12.3	12.2	11.0	9.0	7.2	6.8	6.7	200		
208	-	12.3	-	-	12.7	13.1	-	11.7	11.8	-	10.6	8.5	6.8	6.5	6.5	208		
224	-	-	-	-	10.8	-	-	10.4	10.6	-	9.8	7.8	5.9	5.7	5.8	224		
240	-	-	-	-	-	-	-	8.9	9.1	-	8.9	7.1	5.4	5.2	5.4	240		
256	-	-	-	-	-	-	-	-	-	-	7.7	6.6	4.8	4.8	-	256		
272	-	-	-	-	-	-	-	-	-	-	-	5.6	4.3	4.3	-	272		
288	-	-	-	-	-	-	-	-	-	-	-	3.6	3.6	3.8	-	288		

177.8 ft																
ft	49.2 ft	68.9 ft*			88.6 ft*			108.3 ft*			128.0 ft	147.6 ft	167.3 ft*			ft
		0°	0°	20°	40°	0°	20°	40°	0°	20°	40°	0°	0°	0°	20°	
1,000 lb																
48	51.7	-	-	-	-	-	-	-	-	-	-	-	-	-	-	48
56	48.0	41.6	-	-	-	-	-	-	-	-	-	-	-	-	-	56
64	44.5	38.7	-	-	33.5	-	-	-	-	-	-	-	-	-	-	64
72	41.5	36.2	-	-	31.1	-	-	27.2	-	-	-	-	-	-	-	72
80	38.9	33.6	27.8	21.7	29.2	26.9	-	25.3	-	-	22.3	18.2	13.7	-	-	80
88	36.8	31.4	26.8	21.0	27.1	25.3	21.0	23.8	22.5	-	21.2	17.8	13.7	-	-	88
96	34.6	29.7	25.7	20.4	25.5	23.8	20.6	22.3	21.1	-	20.0	17.2	13.7	-	-	96
104	32.5	27.9	24.7	20.0	24.1	22.4	20.2	21.0	19.9	19.2	18.8	16.3	13.4	-	-	104
112	30.6	26.2	23.8	19.6	22.6	21.1	19.8	19.8	18.7	18.2	17.6	15.4	13.0	-	-	112
120	28.9	24.7	22.8	19.3	21.3	20.0	19.1	18.6	17.7	17.3	16.6	14.4	12.2	11.3	-	120
128	27.3	23.3	21.9	19.0	20.1	19.0	18.4	17.4	16.8	16.4	15.8	13.6	11.5	10.8	-	128
136	25.7	22.1	20.9	18.6	19.0	17.9	17.6	16.3	15.9	15.6	15.0	12.9	10.9	10.3	-	136
144	24.1	20.9	20.0	18.1	18.0	17.1	16.8	15.5	15.0	14.8	14.0	12.2	10.3	9.7	9.0	144
152	22.5	19.7	19.1	17.5	17.1	16.4	16.0	14.7	14.2	14.0	13.1	11.4	9.6	9.2	8.8	152
160	21.2	18.6	18.3	16.9	16.3	15.6	15.3	14.0	13.6	13.3	12.5	10.5	8.9	8.6	8.4	160
168	19.8	17.6	17.5	16.3	15.4	14.9	14.7	13.3	12.9	12.7	11.9	9.9	8.3	8.1	8.0	168
176	18.5	16.7	16.7	15.7	14.5	14.2	14.2	12.7	12.2	12.2	11.3	9.5	7.8	7.6	7.6	176
184	17.2	15.7	15.8	-	13.8	13.5	13.7	11.9	11.6	11.7	10.8	9.0	7.4	7.2	7.2	184
192	15.8	14.8	15.0	-	13.1	12.9	13.1	11.2	10.9	11.1	10.2	8.5	6.9	6.7	6.7	192
200	14.5	13.7	14.1	-	12.4	12.4	-	10.8	10.5	10.6	9.5	8.1	6.4	6.3	6.3	200
208	11.7	12.8	13.1	-	11.7	11.7	-	10.3	10.1	10.2	9.0	7.6	5.9	5.9	6.0	208
216	8.5	12.0	12.2	-	11.1	11.1	-	9.7	9.7	9.7	8.6	7.1	5.5	5.5	5.7	216
224	-	10.5	-	-	10.3	10.3	-	9.2	9.2	-	8.2	6.6	5.2	5.2	5.4	224
240	-	-	-	-	8.3	8.9	-	8.1	8.1	-	7.6	6.0	4.5	4.5	4.7	240
256	-	-	-	-	-	-	-	7.0	-	-	6.8	5.5	4.0	4.0	4.2	256
272	-	-	-	-	-	-	-	-	-	-	5.5	4.7	-	-	-	272
288	-	-	-	-	-	-	-	-	-	-	-	4.0	-	-	-	288

28.5 ft x 27.9 ft													360°			85%		
192.6 ft																		
ft	49.2 ft	68.9 ft*			88.6 ft*			108.3 ft*			128.0 ft	147.6 ft	167.3 ft*			ft		
		0°	0°	20°	40°	0°	20°	40°	0°	20°	40°	0°	0°	0°	20°		40°	
1,000 lb																		
56	41.5	-	-	-	-	-	-	-	-	-	-	-	-	-	-	56		
64	38.7	33.1	-	-	-	-	-	-	-	-	-	-	-	-	-	64		
72	36.2	30.9	-	-	26.7	-	-	-	-	-	-	-	-	-	-	72		
80	33.6	29.0	26.4	-	24.9	-	-	21.2	-	-	17.6	13.4	-	-	-	80		
88	31.6	27.1	24.9	21.0	23.5	21.5	-	20.1	-	-	17.2	13.4	9.3	-	-	88		
96	29.8	25.3	23.6	20.4	21.9	20.4	19.3	19.1	17.7	-	16.7	13.4	9.3	-	-	96		
104	28.1	24.0	22.3	20.0	20.6	19.3	18.4	17.9	16.8	16.0	15.9	13.1	9.3	-	-	104		
112	26.4	22.6	21.1	19.6	19.6	18.3	17.6	16.7	15.8	15.2	14.9	12.5	9.2	-	-	112		
120	24.9	21.3	20.0	18.9	18.3	17.4	16.8	15.9	15.0	14.5	14.1	11.9	9.0	8.1	-	120		
128	23.6	20.1	19.0	18.2	17.2	16.6	16.0	15.0	14.3	13.8	13.4	11.2	8.7	7.9	-	128		
136	22.5	19.0	18.1	17.6	16.1	15.6	15.4	14.1	13.6	13.2	12.7	10.5	8.4	7.9	-	136		
144	21.3	18.1	17.2	16.9	15.4	14.8	14.7	13.3	12.9	12.6	11.9	9.9	8.0	7.5	-	144		
152	20.1	17.3	16.4	16.2	14.7	14.0	14.0	12.5	12.3	12.1	11.2	9.4	7.4	7.0	6.8	152		
160	19.1	16.3	15.8	15.6	13.9	13.3	13.3	11.8	11.6	11.5	10.6	8.9	7.0	6.6	6.5	160		
168	18.1	15.5	15.1	14.9	13.1	12.7	12.7	11.2	11.0	11.0	10.1	8.3	6.6	6.2	6.2	168		
176	17.1	14.7	14.4	14.4	12.4	12.2	12.2	10.7	10.4	10.4	9.6	7.8	6.0	5.8	5.8	176		
184	16.2	14.0	13.9	13.9	11.8	11.6	11.5	10.1	9.9	9.9	9.0	7.4	5.6	5.5	5.5	184		
192	15.2	13.3	13.3	13.3	11.2	10.9	11.1	9.6	9.4	9.4	8.5	7.0	5.2	5.2	5.2	192		
200	14.3	12.8	12.6	-	10.8	10.5	10.6	8.9	8.8	8.9	8.1	6.6	5.0	4.8	4.8	200		
208	13.3	12.2	12.0	-	10.3	10.1	10.2	8.4	8.4	8.5	7.6	6.2	4.6	4.5	4.5	208		
216	12.4	11.5	11.5	-	9.7	9.7	-	8.2	8.0	8.2	7.1	5.8	4.2	4.2	4.2	216		
224	8.6	10.7	10.7	-	9.3	9.2	-	7.8	7.7	7.7	6.8	5.5	3.9	3.9	3.9	224		
232	-	9.8	10.0	-	8.8	8.7	-	7.4	7.4	-	6.5	5.0	3.7	3.7	3.7	232		
240	-	7.8	-	-	8.2	8.3	-	7.0	7.0	-	6.3	4.7	-	-	3.4	240		
256	-	-	-	-	6.8	-	-	6.2	6.2	-	5.5	4.2	-	-	-	256		
272	-	-	-	-	-	-	-	5.0	5.4	-	4.9	3.6	-	-	-	272		
288	-	-	-	-	-	-	-	-	-	-	4.2	-	-	-	-	288		

210.0 ft													206.4 ft			
ft	49.2 ft	68.9 ft*			88.6 ft*			108.3 ft*			128.0 ft	147.6 ft	167.3 ft			ft
		0°	0°	20°	40°	0°	20°	40°	0°	20°	40°	0°	0°	0°	20°	
1,000 lb																
64	32.7	-	-	-	-	-	-	-	-	-	-	-	-	-	-	64
72	30.3	26.1	-	-	-	-	-	-	-	-	-	-	-	-	-	72
80	28.3	24.2	-	-	20.6	-	-	16.7	-	-	12.8	-	-	-	-	80
88	26.3	22.6	21.2	-	19.4	-	-	16.2	-	-	12.8	9.0	-	6.0	88	
96	24.7	21.1	19.9	19.3	18.2	17.4	-	15.7	-	-	12.8	9.0	-	6.0	96	
104	23.3	19.9	18.8	18.3	17.0	16.3	16.1	14.8	14.3	-	12.5	9.0	-	6.0	104	
112	22.0	18.7	17.6	17.4	15.8	15.4	15.2	13.8	13.4	13.4	12.1	9.0	-	6.0	112	
120	20.6	17.6	16.6	16.3	15.0	14.4	14.2	12.9	12.6	12.6	11.4	8.8	-	6.0	120	
128	19.5	16.5	15.8	15.4	14.2	13.6	13.4	12.1	11.8	11.8	10.8	8.5	-	6.0	128	
136	18.5	15.5	15.0	14.7	13.2	12.7	12.7	11.4	11.0	11.0	10.3	8.4	-	6.0	136	
144	17.6	14.7	14.1	13.9	12.4	12.0	12.0	10.6	10.4	10.4	9.6	8.0	-	5.8	144	
152	16.6	14.0	13.4	13.2	11.6	11.4	11.4	9.8	9.8	9.8	8.9	7.4	-	5.7	152	
160	15.7	13.2	12.7	12.6	10.9	10.7	10.7	9.2	9.2	9.3	8.3	6.9	-	5.1	160	
168	14.9	12.5	12.1	12.1	10.3	10.1	10.1	8.6	8.6	8.7	7.7	6.3	-	4.7	168	
176	14.2	11.8	11.5	11.4	9.8	9.6	9.6	8.2	8.0	8.0	7.1	5.8	-	4.2	176	
184	13.7	11.1	11.0	10.8	9.2	9.0	9.0	7.7	7.6	7.6	6.7	5.4	-	3.8	184	
192	13.1	10.5	10.5	10.5	8.7	8.5	8.5	7.2	7.2	7.2	6.3	5.0	-	-	192	
200	12.4	10.1	9.9	10.0	8.2	8.1	8.2	6.8	6.8	6.7	5.9	4.6	-	-	200	
208	11.8	9.7	9.5	9.6	7.7	7.7	7.8	6.3	6.3	6.3	5.6	4.3	-	-	208	
216	11.3	9.3	9.1	-	7.3	7.3	7.3	5.8	5.8	6.0	5.3	4.0	-	-	216	
224	10.5	8.8	8.6	-	6.9	7.0	-	5.5	5.5	5.7	4.9	-	-	-	224	
232	9.2	8.2	8.2	-	6.5	6.5	-	5.2	5.2	5.2	4.5	-	-	-	232	
240	6.6	7.7	7.8	-	6.3	6.1	-	4.9	4.9	4.9	4.1	-	-	-	240	
248	-	6.9	7.4	-	5.8	5.8	-	4.6	4.6	-	4.0	-	-	-	248	
264	-	-	-	-	5.0	5.2	-	3.9	3.9	-	-	-	-	-	264	
280	-	-	-	-	-	-	-	-	3.6	-	-	-	-	-	280	

* SF-A  76,500 lb  98,800 lb  119,700 lb  165,600 lb  211,400 lb  257,300 lb

28.5 ft x 27.9 ft													360°			85%			
118.8 ft																			
ft	49.2 ft		68.9 ft*			88.6 ft*			108.3 ft*			128.0 ft		147.6 ft		167.3 ft*			ft
	0°	0°	20°	40°	0°	20°	40°	0°	20°	40°	0°	0°	0°	20°	40°	0°	20°	40°	
1,000 lb																			
28	91.7	-	-	-	-	-	-	-	-	-	-	-	-	-	-	-	-	-	28
32	83.6	75.7	-	-	-	-	-	-	-	-	-	-	-	-	-	-	-	-	32
36	77.2	72.1	-	-	66.0	-	-	-	-	-	-	-	-	-	-	-	-	-	36
40	71.3	68.4	-	-	63.8	-	-	53.0	-	-	-	-	-	-	-	-	-	-	40
48	61.7	61.1	37.6	-	59.2	-	-	48.5	-	-	40.1	34.9	-	-	-	-	-	-	48
56	54.7	55.1	34.9	-	54.2	35.1	-	44.4	-	-	37.3	32.4	27.8	-	-	-	-	-	56
64	47.7	49.8	32.5	23.6	50.1	33.0	-	40.8	33.0	-	34.5	30.2	26.0	-	-	-	-	-	64
72	43.3	44.6	30.5	22.7	46.4	31.1	22.9	38.0	31.3	22.9	31.8	28.0	24.1	-	-	-	-	-	72
80	39.6	40.8	28.6	21.9	42.7	29.5	22.2	35.3	29.7	22.2	29.9	25.8	22.4	-	-	-	-	-	80
88	36.1	38.0	26.9	21.1	39.5	27.9	21.6	32.8	28.1	21.6	28.0	24.4	20.7	17.4	-	-	-	-	88
96	32.7	35.2	25.7	20.4	37.1	26.4	20.9	30.4	26.6	21.1	26.1	22.8	19.5	16.6	-	-	-	-	96
104	30.4	32.6	24.5	20.0	34.8	25.3	20.3	28.6	25.3	20.6	24.4	21.1	18.2	15.8	-	-	-	-	104
112	28.5	30.1	23.3	19.6	32.5	24.2	19.8	27.0	24.0	20.0	22.9	19.6	16.9	14.7	10.3	-	-	-	112
120	26.5	28.5	22.4	19.2	30.4	23.3	19.4	25.4	22.9	19.8	21.7	18.5	15.7	14.1	10.1	-	-	-	120
128	24.8	26.9	21.5	19.0	28.5	22.4	19.1	23.8	21.8	19.5	20.4	17.5	14.7	13.3	9.8	-	-	-	128
136	23.5	25.5	20.7	-	27.2	21.8	19.0	22.2	20.7	19.1	19.2	16.5	13.8	12.5	9.7	-	-	-	136
144	22.3	24.2	20.1	-	25.9	21.1	18.8	21.1	19.9	18.6	18.1	15.6	13.0	11.8	9.5	-	-	-	144
152	20.7	23.0	19.6	-	24.5	20.4	-	20.1	19.1	18.2	17.1	14.6	12.2	11.2	9.2	-	-	-	152
160	-	22.1	19.2	-	23.3	19.9	-	19.1	18.3	17.7	16.3	13.7	11.4	10.6	9.1	-	-	-	160
168	-	20.0	-	-	22.2	19.4	-	18.1	17.5	-	15.5	12.9	10.7	10.1	9.0	-	-	-	168
176	-	-	-	-	21.3	19.0	-	17.1	16.7	-	14.9	12.2	10.0	9.6	8.8	-	-	-	176
184	-	-	-	-	17.8	-	-	16.4	16.1	-	14.1	11.7	9.5	9.0	8.7	-	-	-	184
200	-	-	-	-	-	-	-	15.1	-	-	12.8	10.6	8.5	8.1	8.1	-	-	-	200
216	-	-	-	-	-	-	-	-	-	-	11.9	9.5	7.5	7.3	7.3	-	-	-	216
232	-	-	-	-	-	-	-	-	-	-	-	8.9	6.8	6.8	-	-	-	-	232
248	-	-	-	-	-	-	-	-	-	-	-	6.4	6.2	6.2	-	-	-	-	248
264	-	-	-	-	-	-	-	-	-	-	-	-	4.7	-	-	-	-	-	264

177.8 ft																			
ft	49.2 ft		68.9 ft*			88.6 ft*			108.3 ft*			128.0 ft		147.6 ft		167.3 ft*			ft
	0°	0°	20°	40°	0°	20°	40°	0°	20°	40°	0°	0°	0°	20°	40°	0°	20°	40°	
1,000 lb																			
40	51.6	41.3	-	-	-	-	-	-	-	-	-	-	-	-	-	-	-	-	40
48	49.6	39.7	-	-	33.2	-	-	-	-	-	-	-	-	-	-	-	-	-	48
56	47.7	38.2	-	-	32.0	-	-	27.1	-	-	22.3	-	-	-	-	-	-	-	56
64	45.8	36.9	33.2	-	31.0	-	-	26.2	-	-	21.9	17.4	-	-	-	-	-	-	64
72	43.9	35.7	31.6	-	30.0	28.7	-	25.4	-	-	21.4	17.4	12.8	-	-	-	-	-	72
80	42.1	34.4	30.2	22.4	28.9	27.6	22.2	24.5	24.6	-	20.9	17.3	12.8	-	-	-	-	-	80
88	40.4	33.4	28.9	21.9	27.9	26.5	21.6	23.6	23.8	20.1	20.2	16.8	12.8	-	-	-	-	-	88
96	38.5	32.3	27.7	21.3	27.1	25.5	21.1	23.0	23.0	19.4	19.6	16.4	12.8	-	-	-	-	-	96
104	36.6	31.3	26.6	20.9	26.2	24.6	20.5	22.2	22.2	18.8	19.0	15.9	12.7	11.0	-	-	-	-	104
112	34.7	30.4	25.5	20.5	25.3	23.8	19.8	21.6	21.6	18.3	18.5	15.4	12.6	11.0	-	-	-	-	112
120	32.7	29.6	24.6	20.1	24.6	22.8	19.0	20.9	20.9	17.7	18.0	15.0	12.3	10.9	-	-	-	-	120
128	30.8	28.8	23.6	19.4	24.0	22.0	18.2	20.3	20.3	17.1	17.4	14.6	12.0	10.8	8.9	-	-	-	128
136	29.1	28.0	22.7	18.5	23.3	21.3	17.6	19.7	19.7	16.5	16.9	14.2	11.6	10.8	8.7	-	-	-	136
144	27.6	26.8	21.8	17.7	22.6	20.6	17.0	19.2	19.1	16.0	16.4	13.7	11.2	10.5	8.4	-	-	-	144
152	26.1	25.4	20.9	16.9	22.0	20.0	16.4	18.7	18.4	15.6	16.0	13.2	10.7	10.1	8.1	-	-	-	152
160	23.5	22.9	20.2	16.4	21.3	19.3	15.7	18.1	17.9	15.0	15.5	12.8	10.3	9.7	7.9	-	-	-	160
168	21.1	20.4	19.5	15.8	20.2	18.7	15.2	17.6	17.3	14.6	14.9	12.4	9.9	9.3	7.6	-	-	-	168
176	19.0	18.4	18.8	15.1	18.7	18.2	14.8	17.1	16.6	14.2	14.4	12.0	9.5	8.9	7.5	-	-	-	176
184	16.9	16.3	17.4	-	16.9	17.4	14.3	16.4	16.2	13.9	14.0	11.4	9.1	8.6	7.3	-	-	-	184
192	15.1	14.4	15.7	-	15.1	16.4	-	15.5	15.8	13.4	13.6	10.9	8.7	8.3	7.0	-	-	-	192
200	12.4	12.7	13.8	-	13.3	14.6	-	13.9	14.9	13.1	13.2	10.5	8.3	7.9	6.9	-	-	-	200
208	8.7	10.9	12.0	-	11.6	12.8	-	12.3	13.4	-	12.8	10.1	7.9	7.6	6.8	-	-	-	208
224	-	6.0	-	-	8.7	9.5	-	9.3	10.2	-	11.2	9.4	7.2	7.0	6.4	-	-	-	224
240	-	-	-	-	4.8	-	-	6.6	7.5	-	8.8	8.4	6.9	6.5	6.2	-	-	-	240
256	-	-	-	-	-	-	-	-	-	-	6.6	6.4	5.1	6.2	6.0	-	-	-	256
272	-	-	-	-	-	-	-	-	-	-	-	4.3	-	4.6	-	-	-	-	272

28.5 ft x 27.9 ft													360°			85%		
192.6 ft																		
ft	49.2 ft	68.9 ft*			88.6 ft*			108.3 ft*			128.0 ft	147.6 ft	167.3 ft*			ft		
		0°	0°	20°	40°	0°	20°	40°	0°	20°	40°	0°	0°	0°	20°		40°	
1,000 lb																		
40	40.2	-	-	-	-	-	-	-	-	-	-	-	-	-	-	40		
48	38.6	31.7	-	-	26.2	-	-	-	-	-	-	-	-	-	-	48		
56	37.0	30.5	-	-	25.2	-	-	20.8	-	-	-	-	-	-	-	56		
64	35.4	29.3	-	-	24.2	-	-	20.2	-	-	16.1	-	-	-	-	64		
72	34.2	28.2	27.4	-	23.4	23.8	-	19.4	-	-	16.1	12.1	-	-	-	72		
80	32.9	27.2	26.3	22.0	22.6	23.0	19.9	18.8	19.3	-	15.6	12.1	8.4	-	-	80		
88	31.7	26.3	25.2	21.3	21.8	22.2	19.2	18.1	18.6	17.2	15.0	11.9	8.4	-	-	88		
96	30.5	25.4	24.3	20.5	21.1	21.4	18.5	17.6	17.9	16.7	14.6	11.8	8.4	-	-	96		
104	29.5	24.5	23.5	19.7	20.4	20.7	17.9	17.0	17.3	16.2	14.3	11.4	8.4	-	-	104		
112	28.6	23.6	22.7	18.9	19.6	20.0	17.4	16.5	16.7	15.6	13.9	11.0	8.4	7.1	-	112		
120	27.7	22.9	21.9	18.1	18.9	19.4	16.7	15.8	16.2	15.2	13.3	10.7	8.1	7.1	-	120		
128	26.8	22.2	21.1	17.4	18.3	18.7	16.1	15.3	15.6	14.8	12.8	10.4	7.8	7.1	-	128		
136	26.0	21.5	20.4	16.9	17.8	18.2	15.6	14.9	15.1	14.4	12.4	10.0	7.6	7.1	6.4	136		
144	25.2	20.9	19.8	16.1	17.2	17.7	15.0	14.5	14.6	13.9	12.1	9.6	7.3	7.1	6.4	144		
152	24.4	20.2	19.1	15.6	16.7	17.1	14.5	14.0	14.1	13.4	11.9	9.2	7.0	7.0	6.4	152		
160	23.5	19.7	18.4	15.0	16.1	16.6	14.2	13.5	13.7	13.1	11.4	9.0	6.7	6.9	6.4	160		
168	21.7	19.1	17.9	14.6	15.7	16.1	13.7	13.0	13.2	12.7	11.1	8.7	6.5	6.8	6.3	168		
176	19.5	18.6	17.5	14.2	15.3	15.7	13.3	12.6	12.8	12.4	10.8	8.4	6.4	6.6	6.2	176		
184	17.6	16.9	17.1	-	14.9	15.3	13.0	12.2	12.4	12.1	10.5	8.1	6.2	6.5	6.1	184		
192	15.7	15.1	16.4	-	14.4	14.9	12.7	11.8	12.1	11.8	10.1	7.9	5.9	6.3	5.9	192		
200	14.1	13.4	14.6	-	13.6	14.6	12.3	11.6	11.8	11.6	9.8	7.6	5.6	6.1	5.6	200		
208	12.4	11.7	12.9	-	12.3	13.4	-	11.3	11.5	11.3	9.5	7.4	5.4	5.9	5.5	208		
216	9.7	10.2	11.1	-	10.7	11.8	-	11.0	11.3	11.0	9.3	7.3	5.3	5.7	5.5	216		
224	-	8.8	9.6	-	9.2	10.2	-	9.5	10.7	-	9.0	7.0	5.0	5.5	5.3	224		
232	-	6.9	-	-	7.8	8.6	-	8.2	9.3	-	8.8	6.8	4.8	5.2	5.2	232		
248	-	-	-	-	5.1	6.1	-	5.8	6.7	-	7.8	6.4	4.5	4.8	5.1	248		
264	-	-	-	-	-	-	-	-	4.4	-	5.7	5.4	3.9	4.5	4.9	264		
280	-	-	-	-	-	-	-	-	-	-	3.8	-	-	3.6	-	280		

210.0 ft														
ft	49.2 ft	68.9 ft*			88.6 ft*			108.3 ft*			128.0 ft	147.6 ft	ft	
		0°	0°	20°	40°	0°	20°	40°	0°	20°	40°	0°		0°
1,000 lb														
48	31.0	25.7	-	-	-	-	-	-	-	-	-	-	-	48
56	29.6	24.4	-	-	19.8	-	-	-	-	-	-	-	-	56
64	28.3	23.5	-	-	19.3	-	-	15.2	-	-	-	-	-	64
72	27.1	22.5	23.0	-	18.5	-	-	15.2	-	-	11.5	7.7	-	72
80	26.1	21.5	22.1	19.3	17.7	18.2	-	14.7	14.3	-	11.4	7.7	-	80
88	25.0	20.7	21.1	18.5	17.0	17.5	16.5	14.1	14.3	-	11.2	7.7	-	88
96	23.9	19.9	20.3	17.8	16.5	16.8	15.8	13.6	14.1	13.9	10.9	7.7	-	96
104	22.9	19.1	19.5	17.2	15.8	16.2	15.3	13.1	13.5	13.6	10.6	7.7	-	104
112	22.0	18.3	18.7	16.5	15.2	15.6	14.7	12.5	13.0	13.2	10.3	7.7	-	112
120	21.3	17.6	18.0	16.0	14.5	14.9	14.3	12.0	12.4	12.7	9.9	7.4	-	120
128	20.6	17.0	17.4	15.3	13.9	14.3	13.9	11.5	11.9	12.2	9.5	7.2	-	128
136	19.8	16.4	16.7	14.7	13.3	13.8	13.3	10.9	11.4	11.8	9.1	6.9	-	136
144	19.1	15.8	16.1	14.3	12.9	13.3	13.0	10.6	10.9	11.3	8.8	6.6	-	144
152	18.4	15.1	15.6	13.8	12.5	12.7	12.5	10.3	10.5	10.7	8.6	6.4	-	152
160	17.9	14.6	15.0	13.4	12.0	12.3	12.3	9.9	10.1	10.3	8.3	6.1	-	160
168	17.4	14.1	14.5	13.0	11.5	11.9	11.9	9.5	9.7	10.0	8.0	5.8	-	168
176	16.8	13.7	14.0	12.6	11.1	11.3	11.5	9.1	9.3	9.7	7.6	5.6	-	176
184	16.5	13.2	13.7	12.3	10.7	11.0	11.2	8.7	9.0	9.3	7.3	5.4	-	184
192	15.5	12.9	13.4	11.8	10.3	10.7	11.0	8.3	8.7	9.0	7.0	5.2	-	192
200	13.8	12.5	13.0	-	10.0	10.3	10.7	8.1	8.3	8.7	6.7	5.0	-	200
208	12.1	11.2	12.0	-	9.7	10.0	10.4	7.8	8.0	8.4	6.5	4.7	-	208
224	9.3	8.2	9.2	-	8.3	9.4	-	7.2	7.5	7.9	6.0	4.3	-	224
240	-	5.7	6.4	-	5.9	6.9	-	6.2	6.9	-	5.6	3.8	-	240
256	-	-	-	-	-	4.4	-	-	4.8	-	5.3	3.5	-	256
272	-	-	-	-	-	-	-	-	-	-	4.0	-	-	272

* SF-A-SL  119,700 lb  165,600 lb  211,400 lb  257,300 lb

SWIHI / WIHI / WIHI-A / SWIHI-SL / WIHI-SL / WIHI-A-SL

AC 350-6

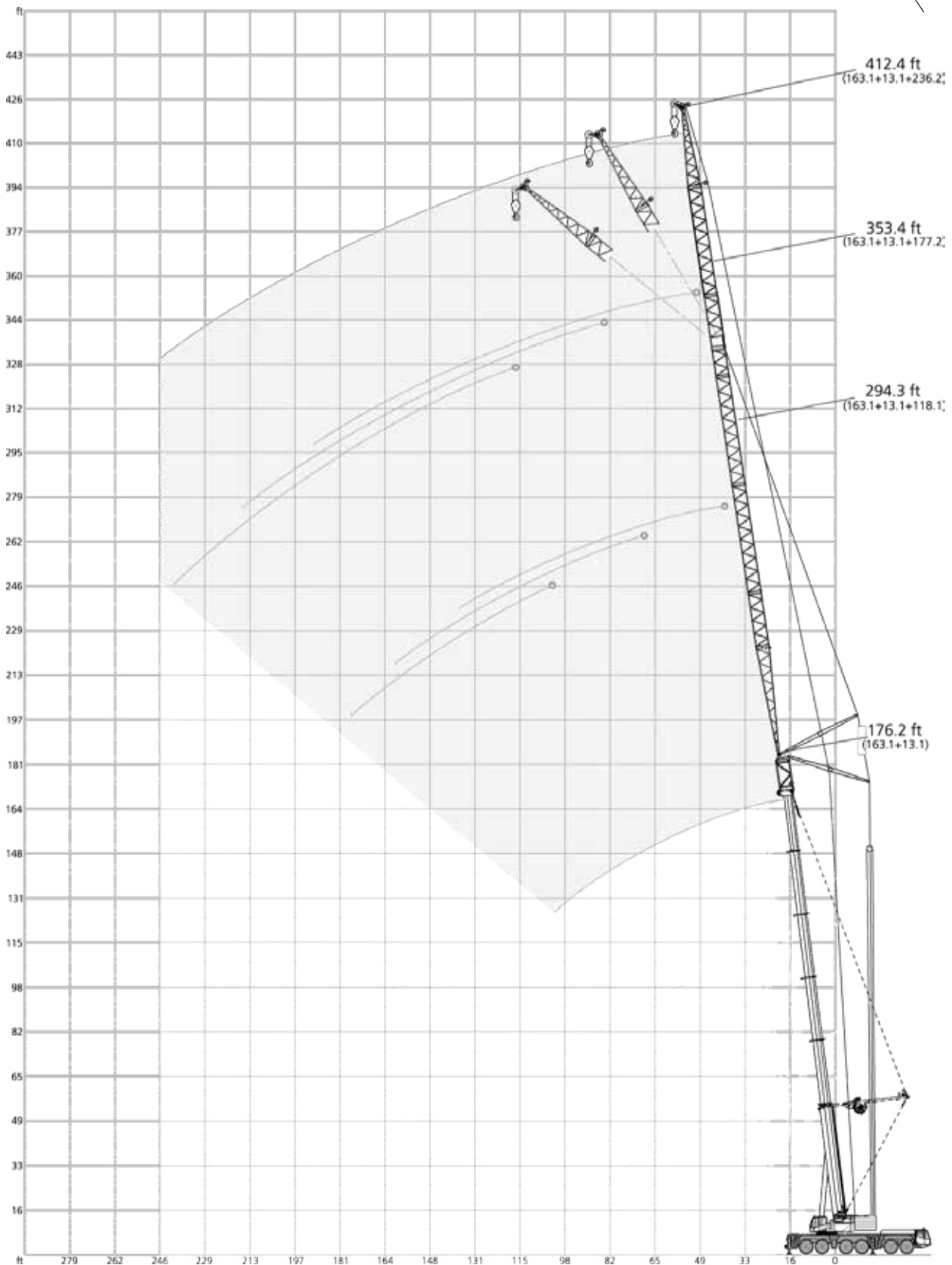

28.5 ft x 27.9 ft																	360°	85%
59.7 ft + 13.1 ft																		
ft	72.2 ft*			78.7 ft			98.4 ft			118.1 ft			137.8 ft			ft		
	82°	73°	65°	82°	73°	65°	82°	73°	65°	82°	73°	65°	82°	73°	65°			
1,000 lb																		
40	134.0	-	-	100.1	-	-	-	-	-	-	-	-	-	-	-	40		
48	127.0	-	-	100.1	-	-	-	-	-	-	-	-	-	-	-	48		
56	116.7	-	-	99.1	-	-	91.2	-	-	71.4	-	-	-	-	-	56		
64	102.7	-	-	95.5	-	-	88.9	-	-	69.9	-	-	56.7	-	-	64		
72	82.1	93.1	-	88.4	93.4	-	86.0	-	-	68.6	-	-	55.6	-	-	72		
80	-	83.3	80.1	-	83.7	-	79.0	80.0	-	67.2	-	-	54.5	-	-	80		
88	-	-	72.4	-	75.7	72.7	69.4	74.7	-	63.8	65.9	-	53.5	-	-	88		
96	-	-	-	-	-	66.2	58.5	68.1	-	60.1	63.6	-	52.2	-	-	96		
104	-	-	-	-	-	-	-	62.6	60.0	54.8	61.0	-	50.5	51.8	-	104		
112	-	-	-	-	-	-	-	-	55.1	46.7	56.9	54.2	48.8	50.9	-	112		
120	-	-	-	-	-	-	-	-	-	-	52.2	50.0	45.6	49.4	47.8	120		
128	-	-	-	-	-	-	-	-	-	-	46.3	46.2	39.6	47.0	45.3	128		
136	-	-	-	-	-	-	-	-	-	-	-	42.7	33.7	43.6	42.0	136		
144	-	-	-	-	-	-	-	-	-	-	-	-	-	39.4	38.9	144		
152	-	-	-	-	-	-	-	-	-	-	-	-	-	-	36.3	152		

ft	157.5 ft			177.2 ft			196.9 ft**			216.5 ft			236.2 ft**			ft
	82°	73°	65°	82°	73°	65°	82°	73°	65°	82°	73°	65°	82°	73°	65°	
1,000 lb																
72	44.3	-	-	-	-	-	-	-	-	-	-	-	-	-	-	72
80	43.5	-	-	35.4	-	-	-	-	-	-	-	-	-	-	-	80
88	42.7	-	-	34.7	-	-	29.4	-	-	-	-	-	-	-	-	88
96	42.1	-	-	34.1	-	-	28.8	-	-	24.0	-	-	-	-	-	96
104	41.3	-	-	33.5	-	-	28.4	-	-	23.5	-	-	18.6	-	-	104
112	40.7	40.8	-	32.8	-	-	28.0	-	-	23.1	-	-	18.5	-	-	112
120	40.1	40.2	-	32.5	32.3	-	27.6	-	-	22.8	-	-	18.2	-	-	120
128	39.5	39.7	-	32.0	32.0	-	27.0	26.9	-	22.4	-	-	17.8	-	-	128
136	37.2	39.3	39.0	31.6	31.4	-	26.2	26.5	-	22.1	-	-	17.1	-	-	136
144	33.2	37.9	37.4	31.3	31.1	-	25.4	26.0	-	21.4	21.5	-	16.6	-	-	144
152	29.2	36.0	35.6	29.8	30.8	30.8	24.6	25.5	-	20.6	21.1	-	16.0	15.8	-	152
160	-	33.1	33.3	27.2	30.1	30.6	23.8	24.9	25.3	19.8	20.6	-	15.5	15.6	-	160
168	-	-	31.3	24.5	29.0	29.9	22.6	24.1	24.6	19.1	19.9	-	14.9	15.2	-	168
176	-	-	29.4	-	27.4	28.3	21.2	23.3	23.9	18.4	19.3	19.9	14.2	14.8	-	176
184	-	-	-	-	-	26.6	19.8	22.3	23.2	17.7	18.6	19.3	13.7	14.3	14.8	184
192	-	-	-	-	-	25.1	-	21.4	22.5	17.1	18.0	18.6	13.1	13.8	14.2	192
200	-	-	-	-	-	-	-	20.5	21.6	16.5	17.4	17.9	12.7	13.2	13.7	200
208	-	-	-	-	-	-	-	-	20.7	16.0	17.0	17.5	12.3	12.8	13.2	208
216	-	-	-	-	-	-	-	-	-	-	16.6	17.0	11.9	12.4	12.8	216
224	-	-	-	-	-	-	-	-	-	-	-	16.5	11.7	12.1	12.4	224
232	-	-	-	-	-	-	-	-	-	-	-	-	-	11.8	12.0	232
240	-	-	-	-	-	-	-	-	-	-	-	-	-	11.4	11.8	240
248	-	-	-	-	-	-	-	-	-	-	-	-	-	-	11.3	248

* SWIHI ** WIHI-A

98,800 lb 119,700 lb 165,600 lb 211,400 lb 257,300 lb

28.5 ft x 27.9 ft																	360°	85%
74.5 ft + 13.1 ft																		
		72.2 ft*			78.7 ft			98.4 ft			118.1 ft			137.8 ft				
		82°	73°	65°	82°	73°	65°	82°	73°	65°	82°	73°	65°	82°	73°	65°		
ft		1,000 lb															ft	
40		123.7	-	-	-	-	-	88.1	-	-	-	-	-	-	-	-	40	
48		121.2	-	-	100.1	-	-	86.4	-	-	68.2	-	-	-	-	-	48	
56		116.6	-	-	100.1	-	-	85.0	-	-	66.9	-	-	54.3	-	-	56	
64		106.2	-	-	97.1	-	-	83.6	-	-	65.5	-	-	53.1	-	-	64	
72		90.3	91.1	-	92.3	-	-	81.6	-	-	64.4	-	-	52.3	-	-	72	
80		-	81.6	-	77.3	81.8	-	76.8	79.4	-	63.2	63.3	-	51.2	-	-	80	
88		-	73.7	70.0	-	74.1	-	71.1	73.2	-	61.5	62.3	-	50.4	-	-	88	
96		-	-	63.7	-	67.5	64.2	62.5	66.6	-	59.5	61.4	-	49.6	48.7	-	96	
104		-	-	58.2	-	-	58.6	-	61.3	57.8	57.2	59.8	-	48.8	48.0	-	104	
112		-	-	-	-	-	-	-	-	52.9	50.0	55.3	51.8	48.0	47.4	-	112	
120		-	-	-	-	-	-	-	-	48.9	-	51.3	47.7	46.7	46.8	46.2	120	
128		-	-	-	-	-	-	-	-	-	-	47.4	44.2	42.1	45.5	43.4	128	
136		-	-	-	-	-	-	-	-	-	-	-	40.8	36.7	42.9	40.2	136	
144		-	-	-	-	-	-	-	-	-	-	-	38.0	-	40.1	37.4	144	
152		-	-	-	-	-	-	-	-	-	-	-	-	-	-	34.7	152	
160		-	-	-	-	-	-	-	-	-	-	-	-	-	-	32.5	160	

157.5 ft																	177.2 ft			196.9 ft**			216.5 ft			236.2 ft**		
		82°	73°	65°	82°	73°	65°	82°	73°	65°	82°	73°	65°	82°	73°	65°	82°	73°	65°									
ft		1,000 lb																		ft								
64		42.7	-	-	-	-	-	-	-	-	-	-	-	-	-	-	-	-	-	64								
72		41.9	-	-	34.2	-	-	28.7	-	-	-	-	-	-	-	-	-	-	-	72								
80		41.1	-	-	33.4	-	-	28.1	-	-	23.5	-	-	20.9	-	-	-	-	-	80								
88		40.3	-	-	32.7	-	-	27.6	-	-	23.0	-	-	20.4	-	-	-	-	-	88								
96		39.6	-	-	32.1	-	-	27.1	-	-	22.6	-	-	20.0	-	-	-	-	-	96								
104		39.1	38.9	-	31.6	-	-	26.6	-	-	22.2	-	-	19.6	-	-	-	-	-	104								
112		38.6	38.3	-	31.1	31.1	-	26.2	-	-	21.8	-	-	19.1	-	-	-	-	-	112								
120		38.2	37.8	-	30.7	30.5	-	25.9	25.7	-	21.5	-	-	18.5	-	-	-	-	-	120								
128		37.7	37.4	-	30.3	30.0	-	25.4	25.2	-	21.2	20.8	-	17.9	-	-	-	-	-	128								
136		36.7	37.1	36.9	30.0	29.6	-	25.0	24.8	-	20.8	20.6	-	17.3	-	-	-	-	-	136								
144		33.8	36.6	35.7	29.7	29.3	29.1	24.5	24.5	-	20.4	20.3	-	16.7	16.9	-	-	-	-	144								
152		30.4	35.9	34.1	29.1	29.1	28.8	24.0	24.2	24.0	20.0	20.0	-	16.0	16.5	-	-	-	-	152								
160		-	34.0	31.7	27.2	28.8	28.6	23.6	23.9	23.9	19.5	19.6	-	15.5	15.9	-	-	-	-	160								
168		-	32.0	29.7	25.3	28.3	27.9	22.8	23.6	23.7	18.8	19.2	18.8	14.9	15.5	-	-	-	-	168								
176		-	-	27.8	23.4	27.7	26.8	21.8	23.2	23.4	18.2	18.8	18.6	14.2	15.1	-	-	-	-	176								
184		-	-	-	-	26.9	25.3	20.7	22.6	23.1	17.7	18.4	18.4	13.7	14.5	15.0	-	-	-	184								
192		-	-	-	-	-	23.7	19.6	21.9	22.7	17.3	18.0	18.2	13.1	14.0	14.4	-	-	-	192								
200		-	-	-	-	-	22.4	-	21.0	21.5	16.9	17.4	18.0	12.7	13.5	13.9	-	-	-	200								
208		-	-	-	-	-	-	-	20.0	20.3	16.4	17.0	17.6	12.3	12.9	13.4	-	-	-	208								
216		-	-	-	-	-	-	-	-	19.0	15.9	16.6	17.2	11.9	12.4	13.0	-	-	-	216								
224		-	-	-	-	-	-	-	-	-	-	16.2	16.8	11.7	12.1	12.6	-	-	-	224								
232		-	-	-	-	-	-	-	-	-	-	-	16.4	-	11.8	12.2	-	-	-	232								
240		-	-	-	-	-	-	-	-	-	-	-	-	-	11.4	11.8	-	-	-	240								
248		-	-	-	-	-	-	-	-	-	-	-	-	-	-	11.5	-	-	-	248								

* SWIHI ** WIHI-A

☰ 98,800 lb 119,700 lb 165,600 lb 211,400 lb 257,300 lb

28.5 ft x 27.9 ft										360°			85%								
89.2 ft + 13.1 ft																					
72.2 ft*										78.7 ft			98.4 ft			118.1 ft			137.8 ft		
82° 73° 65°										82° 73° 65°			82° 73° 65°			82° 73° 65°			82° 73° 65°		
ft	1,000 lb									ft											
40	112.1	-	-	-	-	-	-	-	-	-	-	-	-	-	-	-	-	-	-	40	
48	110.2	-	-	-	-	-	99.4	-	-	79.2	-	-	-	-	-	-	-	-	-	48	
56	108.4	-	-	-	-	-	98.3	-	-	78.0	-	-	61.7	-	-	-	49.3	-	-	56	
64	104.0	-	-	-	-	-	96.2	-	-	76.9	-	-	60.6	-	-	-	48.3	-	-	64	
72	95.4	89.5	-	-	-	-	92.9	-	-	75.9	-	-	59.5	-	-	-	47.4	-	-	72	
80	-	80.3	-	-	-	-	84.1	80.5	-	74.0	73.3	-	58.7	-	-	-	46.7	-	-	80	
88	-	72.4	-	-	-	-	-	72.8	-	71.8	71.0	-	57.8	57.5	-	-	46.0	-	-	88	
96	-	65.9	62.0	-	-	-	-	66.2	-	66.2	65.4	-	57.1	56.8	-	-	45.4	45.1	-	96	
104	-	-	56.7	-	-	-	-	-	-	57.1	59.7	-	55.1	55.7	-	-	44.9	44.5	-	104	
112	-	-	-	-	-	-	-	-	-	-	55.1	50.9	52.3	54.2	49.8	-	44.5	43.9	-	112	
120	-	-	-	-	-	-	-	-	-	-	-	47.0	45.2	50.1	46.1	-	43.5	43.6	-	120	
128	-	-	-	-	-	-	-	-	-	-	-	43.4	-	-	46.2	42.6	41.3	42.9	-	128	
136	-	-	-	-	-	-	-	-	-	-	-	-	-	42.9	39.5	37.3	41.5	38.6	-	136	
144	-	-	-	-	-	-	-	-	-	-	-	-	-	-	36.7	33.2	38.9	35.8	-	144	
152	-	-	-	-	-	-	-	-	-	-	-	-	-	-	-	-	36.3	33.4	-	152	
160	-	-	-	-	-	-	-	-	-	-	-	-	-	-	-	-	-	31.2	-	160	
168	-	-	-	-	-	-	-	-	-	-	-	-	-	-	-	-	-	29.3	-	168	

157.5 ft										177.2 ft			196.9 ft**			216.5 ft			236.2 ft**		
82° 73° 65°										82° 73° 65°			82° 73° 65°			82° 73° 65°			82° 73° 65°		
ft	1,000 lb									ft											
64	39.6	-	-	-	-	-	-	-	-	-	-	-	-	-	-	-	-	-	-	64	
72	38.8	-	-	-	-	-	31.8	-	-	-	-	-	-	-	-	-	-	-	-	72	
80	38.1	-	-	-	-	-	31.0	-	-	26.0	-	-	23.7	-	-	-	-	-	-	80	
88	37.5	-	-	-	-	-	30.5	-	-	25.6	-	-	23.2	-	-	-	19.5	-	-	88	
96	37.0	-	-	-	-	-	29.9	-	-	25.1	-	-	22.8	-	-	-	19.1	-	-	96	
104	36.3	-	-	-	-	-	29.4	-	-	24.6	-	-	22.4	-	-	-	18.7	-	-	104	
112	35.9	35.7	-	-	-	-	28.9	28.6	-	24.2	-	-	22.0	-	-	-	18.3	-	-	112	
120	35.5	35.1	-	-	-	-	28.5	28.2	-	24.0	23.5	-	21.6	-	-	-	17.7	-	-	120	
128	35.2	34.7	-	-	-	-	28.2	27.8	-	23.7	23.3	-	21.3	-	-	-	17.2	-	-	128	
136	34.9	34.5	-	-	-	-	28.0	27.4	-	23.4	23.0	-	21.0	20.6	-	-	16.7	-	-	136	
144	33.2	34.2	33.4	-	-	-	27.8	27.2	-	23.2	22.7	-	20.5	20.3	-	-	16.2	16.7	-	144	
152	31.0	33.9	32.6	-	-	-	27.4	27.1	26.7	22.9	22.5	-	20.0	20.0	-	-	15.8	16.3	-	152	
160	-	33.0	30.4	-	-	-	26.3	26.8	26.5	22.8	22.3	21.7	19.5	19.8	-	-	15.3	15.9	-	160	
168	-	31.3	28.5	-	-	-	25.2	26.6	26.1	22.4	22.2	21.5	18.9	19.4	-	-	14.7	15.4	-	168	
176	-	29.4	26.7	-	-	-	24.0	26.5	25.5	21.9	22.1	21.4	18.2	18.8	18.5	-	14.2	14.8	-	176	
184	-	-	25.1	-	-	-	-	25.9	24.0	21.0	21.7	21.4	17.6	18.4	18.3	13.7	14.5	15.2	-	184	
192	-	-	-	-	-	-	-	25.1	22.4	20.1	21.3	21.3	17.1	18.0	18.0	13.1	14.0	14.7	-	192	
200	-	-	-	-	-	-	-	-	21.1	-	20.7	20.4	16.7	17.4	17.8	12.6	13.5	14.1	-	200	
208	-	-	-	-	-	-	-	-	19.9	-	20.2	19.1	16.3	17.0	17.5	12.2	12.9	13.6	-	208	
216	-	-	-	-	-	-	-	-	-	-	19.7	17.9	15.9	16.6	17.2	11.9	12.4	13.0	-	216	
224	-	-	-	-	-	-	-	-	-	-	-	16.9	-	16.2	16.6	11.7	12.1	12.6	-	224	
232	-	-	-	-	-	-	-	-	-	-	-	-	-	16.2	15.8	11.3	11.8	12.3	-	232	
240	-	-	-	-	-	-	-	-	-	-	-	-	-	-	14.9	-	11.6	12.0	-	240	
248	-	-	-	-	-	-	-	-	-	-	-	-	-	-	-	-	11.1	11.7	-	248	
256	-	-	-	-	-	-	-	-	-	-	-	-	-	-	-	-	-	11.2	-	256	

* SWIHI ** WIHI-A

98,800 lb 119,700 lb 165,600 lb 211,400 lb 257,300 lb

28.5 ft x 27.9 ft													360°			85%		
104.0 ft + 13.1 ft																		
ft	72.2 ft*			78.7 ft			98.4 ft			118.1 ft			137.8 ft			ft		
	82°	73°	65°	82°	73°	65°	82°	73°	65°	82°	73°	65°	82°	73°	65°			
1,000 lb																		
48	91.1	-	-	-	-	-	66.7	-	-	-	-	-	-	-	-	48		
56	87.5	-	-	82.3	-	-	65.7	-	-	52.9	-	-	-	-	-	56		
64	83.0	-	-	79.4	-	-	64.8	-	-	52.0	-	-	41.6	-	-	64		
72	79.9	-	-	76.3	-	-	64.2	-	-	51.2	-	-	41.0	-	-	72		
80	76.3	69.5	-	73.5	-	-	62.9	-	-	50.6	-	-	40.3	-	-	80		
88	-	64.7	-	70.0	64.5	-	60.8	60.0	-	50.0	-	-	39.9	-	-	88		
96	-	60.9	-	-	60.4	-	58.6	56.8	-	49.2	48.1	-	39.4	-	-	96		
104	-	-	51.4	-	57.6	-	56.3	53.7	-	48.3	47.3	-	38.9	-	-	104		
112	-	-	48.3	-	-	47.5	-	50.8	45.3	47.2	46.4	-	38.6	38.1	-	112		
120	-	-	-	-	-	44.8	-	-	42.7	44.6	44.4	-	38.3	37.6	-	120		
128	-	-	-	-	-	-	-	-	40.2	-	42.5	38.4	37.6	37.0	-	128		
136	-	-	-	-	-	-	-	-	37.8	-	40.7	36.4	36.2	36.3	-	136		
144	-	-	-	-	-	-	-	-	35.2	-	38.1	34.1	34.7	35.5	32.5	144		
152	-	-	-	-	-	-	-	-	-	-	-	31.9	-	34.6	31.0	152		
160	-	-	-	-	-	-	-	-	-	-	-	-	-	32.5	29.0	160		
168	-	-	-	-	-	-	-	-	-	-	-	-	-	-	27.1	168		
176	-	-	-	-	-	-	-	-	-	-	-	-	-	-	25.4	176		

ft	157.5 ft			177.2 ft			196.9 ft**			216.5 ft			236.2 ft**			ft
	82°	73°	65°	82°	73°	65°	82°	73°	65°	82°	73°	65°	82°	73°	65°	
1,000 lb																
72	33.5	-	-	-	-	-	-	-	-	-	-	-	-	-	-	72
80	33.0	-	-	26.6	-	-	24.0	-	-	20.9	-	-	-	-	-	80
88	32.4	-	-	26.1	-	-	23.7	-	-	20.4	-	-	16.9	-	-	88
96	32.0	-	-	25.9	-	-	23.3	-	-	20.0	-	-	16.6	-	-	96
104	31.7	-	-	25.5	-	-	23.0	-	-	19.6	-	-	16.3	-	-	104
112	31.3	30.4	-	25.1	-	-	22.7	-	-	19.2	-	-	15.9	-	-	112
120	31.0	30.3	-	24.8	23.1	-	22.3	-	-	18.9	-	-	15.6	-	-	120
128	30.8	30.1	-	24.6	23.1	-	21.9	-	-	18.6	-	-	15.3	-	-	128
136	30.5	30.0	-	24.3	23.1	-	21.5	20.3	-	18.4	-	-	15.1	-	-	136
144	30.2	29.8	-	24.1	23.1	-	21.3	20.3	-	18.1	17.8	-	14.8	-	-	144
152	29.7	29.7	27.2	24.0	23.1	-	21.1	20.3	-	17.8	17.6	-	14.5	13.4	-	152
160	29.0	29.5	26.6	23.9	23.1	20.9	20.9	20.1	-	17.6	17.3	-	14.2	13.4	-	160
168	-	28.8	25.6	23.8	23.1	20.9	20.6	20.1	-	17.4	17.1	-	13.9	13.4	-	168
176	-	27.7	24.4	23.8	23.1	20.9	20.3	20.1	18.1	17.2	17.0	-	13.5	13.4	-	176
184	-	-	22.9	-	23.1	20.9	20.1	19.9	18.1	17.0	16.8	15.9	13.1	13.2	-	184
192	-	-	21.5	-	23.0	20.4	19.8	19.8	18.0	16.7	16.7	15.9	12.7	12.9	11.5	192
200	-	-	-	-	22.2	19.1	19.5	19.7	17.8	16.4	16.6	15.9	12.3	12.7	11.5	200
208	-	-	-	-	-	17.9	-	19.5	17.0	16.1	16.4	15.9	12.0	12.4	11.5	208
216	-	-	-	-	-	16.8	-	19.2	15.9	15.7	16.1	15.9	11.7	12.1	11.5	216
224	-	-	-	-	-	-	-	-	15.1	-	15.8	14.9	11.4	11.9	11.5	224
232	-	-	-	-	-	-	-	-	14.1	-	15.6	14.1	11.2	11.6	11.4	232
240	-	-	-	-	-	-	-	-	-	-	15.3	13.1	10.9	11.3	11.3	240
248	-	-	-	-	-	-	-	-	-	-	-	12.3	-	11.1	11.0	248
256	-	-	-	-	-	-	-	-	-	-	-	-	-	-	10.6	256
264	-	-	-	-	-	-	-	-	-	-	-	-	-	-	9.9	264
272	-	-	-	-	-	-	-	-	-	-	-	-	-	-	9.3	272

* SWIHI ** WIHI-A

98,800 lb 119,700 lb 165,600 lb 211,400 lb 257,300 lb

28.5 ft x 27.9 ft										360°			85%			
118.8 ft + 13.1 ft																
72.2 ft*		78.7 ft			98.4 ft			118.1 ft			137.8 ft					
82° 73° 65°		82° 73° 65°			82° 73° 65°			82° 73° 65°			82° 73° 65°					
ft	1,000 lb											ft				
48	80.2	-	-	-	-	-	-	-	-	-	-	-	48			
56	79.1	-	-	72.4	-	-	58.5	-	-	-	-	-	56			
64	78.0	-	-	71.6	-	-	57.9	-	-	45.7	-	-	64			
72	74.6	-	-	69.9	-	-	57.1	-	-	45.0	-	36.8	72			
80	69.6	61.9	-	66.0	-	-	56.5	-	-	44.5	-	36.3	80			
88	-	57.7	-	62.7	-	-	55.7	-	-	44.1	-	35.8	88			
96	-	54.1	-	-	53.9	-	54.9	50.8	-	43.6	-	35.4	96			
104	-	51.3	-	-	51.1	-	53.0	48.0	-	43.2	41.8	35.1	104			
112	-	-	41.5	-	-	41.8	-	45.3	-	42.9	40.9	34.8	32.8	112		
120	-	-	39.4	-	-	39.6	-	42.8	37.5	41.6	39.3	34.7	32.8	120		
128	-	-	-	-	-	-	-	41.1	35.5	39.9	37.6	34.4	32.6	128		
136	-	-	-	-	-	-	-	-	33.7	-	35.9	31.9	33.9	31.9	136	
144	-	-	-	-	-	-	-	-	32.2	-	34.7	30.3	32.9	31.1	144	
152	-	-	-	-	-	-	-	-	-	-	-	28.7	-	30.3	26.7	152
160	-	-	-	-	-	-	-	-	-	-	-	27.7	-	29.5	25.5	160
168	-	-	-	-	-	-	-	-	-	-	-	-	-	28.7	24.4	168
176	-	-	-	-	-	-	-	-	-	-	-	-	-	-	23.5	176
184	-	-	-	-	-	-	-	-	-	-	-	-	-	-	22.5	184

157.5 ft		177.2 ft			196.9 ft**			216.5 ft			236.2 ft**					
82° 73° 65°		82° 73° 65°			82° 73° 65°			82° 73° 65°			82° 73° 65°					
ft	1,000 lb											ft				
72	29.3	-	-	-	-	-	-	-	-	-	-	-	-	72		
80	29.3	-	-	22.3	-	-	22.0	-	-	-	-	-	-	80		
88	29.2	-	-	22.3	-	-	21.5	-	-	18.4	-	-	-	88		
96	28.8	-	-	22.3	-	-	21.1	-	-	18.0	-	-	14.1	96		
104	28.5	-	-	22.2	-	-	20.7	-	-	17.7	-	-	14.0	104		
112	28.2	-	-	22.0	-	-	20.3	-	-	17.4	-	-	13.9	112		
120	27.9	24.9	-	22.0	-	-	20.0	-	-	17.1	-	-	13.7	120		
128	27.7	24.9	-	22.0	18.5	-	19.7	-	-	16.9	-	-	13.6	128		
136	27.6	24.9	-	21.9	18.5	-	19.5	-	-	16.6	-	-	13.5	136		
144	27.5	24.9	-	21.7	18.5	-	19.2	18.6	-	16.3	-	-	13.2	144		
152	27.3	24.9	-	21.6	18.5	-	18.9	18.5	-	16.1	15.0	-	13.0	10.8	152	
160	26.8	24.9	22.2	21.6	18.5	-	18.8	18.4	-	15.9	15.0	-	12.9	10.8	160	
168	26.5	24.9	21.8	21.6	18.5	16.5	18.7	18.2	-	15.8	15.0	-	12.7	10.8	168	
176	-	24.5	21.2	21.6	18.5	16.5	18.5	18.1	-	15.7	15.0	-	12.4	10.8	176	
184	-	24.1	20.6	21.6	18.5	16.5	18.4	18.0	16.2	15.5	14.9	-	12.2	10.8	184	
192	-	-	19.9	-	18.5	16.5	18.3	17.8	15.8	15.4	14.8	12.8	12.1	10.8	192	
200	-	-	18.9	-	18.5	16.4	18.3	17.7	15.2	15.3	14.8	12.8	11.8	10.8	200	
208	-	-	-	-	18.5	16.0	-	17.5	14.8	15.2	14.8	12.8	11.6	10.8	9.0	208
216	-	-	-	-	-	15.7	-	17.2	14.4	15.2	14.8	12.8	11.5	10.8	9.0	216
224	-	-	-	-	-	-	-	16.9	13.7	-	14.8	12.8	11.2	10.8	9.0	224
232	-	-	-	-	-	-	-	-	13.0	-	14.8	12.6	10.9	10.8	9.0	232
240	-	-	-	-	-	-	-	-	12.2	-	14.8	11.9	10.7	10.6	9.0	240
248	-	-	-	-	-	-	-	-	-	-	14.4	11.3	-	10.6	9.0	248
256	-	-	-	-	-	-	-	-	-	-	-	10.6	-	10.6	8.8	256
264	-	-	-	-	-	-	-	-	-	-	-	-	-	-	8.7	264
272	-	-	-	-	-	-	-	-	-	-	-	-	-	-	8.2	272
280	-	-	-	-	-	-	-	-	-	-	-	-	-	-	7.8	280

* SWIHI ** WIHI-A

98,800 lb 119,700 lb 165,600 lb 211,400 lb 257,300 lb



 28.5 ft x 27.9 ft 360° 85%

 133.5 ft +  13.1 ft

ft	72.2 ft*			78.7 ft			98.4 ft			118.1 ft			137.8 ft			ft
	82°	73°	65°	82°	73°	65°	82°	73°	65°	82°	73°	65°	82°	73°	65°	
1,000 lb																
56	65.7	-	-	-	-	-	48.1	-	-	-	-	-	-	-	-	56
64	64.8	-	-	60.7	-	-	48.1	-	-	37.7	-	-	-	-	-	64
72	64.0	-	-	60.2	-	-	47.6	-	-	37.7	-	-	29.3	-	-	72
80	60.8	-	-	58.6	-	-	47.3	-	-	37.7	-	-	29.3	-	-	80
88	57.7	50.7	-	56.5	-	-	46.8	-	-	37.6	-	-	29.3	-	-	88
96	-	47.6	-	-	-	-	46.2	-	-	37.5	-	-	29.3	-	-	96
104	-	45.1	-	-	44.0	-	45.1	40.6	-	37.3	-	-	29.3	-	-	104
112	-	-	-	-	41.6	-	43.8	38.7	-	37.0	32.8	-	29.3	24.9	-	112
120	-	-	-	-	-	-	-	36.9	-	36.5	32.6	-	29.3	24.9	-	120
128	-	-	-	-	-	-	-	35.0	-	35.6	32.0	-	29.3	24.9	-	128
136	-	-	-	-	-	-	-	33.8	29.0	-	30.9	-	29.1	24.9	-	136
144	-	-	-	-	-	-	-	-	27.7	-	29.9	26.0	29.0	24.9	-	144
152	-	-	-	-	-	-	-	-	26.5	-	29.0	24.7	-	24.9	22.4	152
160	-	-	-	-	-	-	-	-	-	-	-	23.5	-	24.8	21.6	160
168	-	-	-	-	-	-	-	-	-	-	-	22.6	-	24.4	20.7	168
176	-	-	-	-	-	-	-	-	-	-	-	-	-	23.7	19.8	176
184	-	-	-	-	-	-	-	-	-	-	-	-	-	-	19.0	184
192	-	-	-	-	-	-	-	-	-	-	-	-	-	-	18.3	192

ft	157.5 ft			177.2 ft			196.9 ft**			216.5 ft			236.2 ft**			ft
	82°	73°	65°	82°	73°	65°	82°	73°	65°	82°	73°	65°	82°	73°	65°	
1,000 lb																
80	22.3	-	-	19.8	-	-	-	-	-	-	-	-	-	-	-	80
88	22.3	-	-	19.8	-	-	18.0	-	-	14.6	-	-	-	-	-	88
96	22.3	-	-	19.8	-	-	17.9	-	-	14.6	-	-	10.6	-	-	96
104	22.3	-	-	19.8	-	-	17.7	-	-	14.6	-	-	10.6	-	-	104
112	22.3	-	-	19.8	-	-	17.4	-	-	14.6	-	-	10.6	-	-	112
120	22.3	-	-	19.8	-	-	17.1	-	-	14.4	-	-	10.6	-	-	120
128	22.3	18.5	-	19.8	-	-	16.9	-	-	14.3	-	-	10.6	-	-	128
136	22.3	18.5	-	19.8	16.1	-	16.6	-	-	14.1	-	-	10.6	-	-	136
144	22.3	18.5	-	19.7	16.1	-	16.4	-	-	14.0	-	-	10.6	-	-	144
152	22.3	18.5	-	19.6	16.1	-	16.3	14.3	-	13.9	11.0	-	10.6	-	-	152
160	22.3	18.5	-	19.5	16.1	-	16.2	14.3	-	13.6	11.0	-	10.6	7.5	-	160
168	22.3	18.5	16.5	19.3	16.1	-	16.0	14.3	-	13.4	11.0	-	10.6	7.5	-	168
176	-	18.5	16.5	19.2	16.1	-	15.9	14.3	-	13.4	11.0	-	10.6	7.5	-	176
184	-	18.5	16.5	19.2	16.1	13.8	15.8	14.3	-	13.3	11.0	-	10.5	7.5	-	184
192	-	18.5	16.4	-	16.1	13.6	15.7	14.3	11.9	13.2	11.0	-	10.3	7.5	-	192
200	-	-	15.9	-	16.1	13.5	15.7	14.3	11.7	13.0	11.0	9.3	10.2	7.5	-	200
208	-	-	15.3	-	16.1	13.2	15.7	14.3	11.5	13.0	11.0	9.3	10.1	7.5	-	208
216	-	-	-	-	16.1	12.8	-	14.1	11.3	13.0	11.0	9.3	10.1	7.5	5.7	216
224	-	-	-	-	-	12.4	-	13.9	10.9	13.0	11.0	9.3	10.1	7.5	5.7	224
232	-	-	-	-	-	12.0	-	13.7	10.5	-	11.0	9.2	10.1	7.5	5.7	232
240	-	-	-	-	-	-	-	-	10.2	-	11.0	9.1	10.1	7.5	5.7	240
248	-	-	-	-	-	-	-	-	9.9	-	11.0	8.9	10.1	7.5	5.7	248
256	-	-	-	-	-	-	-	-	-	-	-	8.6	-	7.5	5.7	256
264	-	-	-	-	-	-	-	-	-	-	-	8.5	-	7.5	5.7	264
272	-	-	-	-	-	-	-	-	-	-	-	-	-	7.5	5.7	272
280	-	-	-	-	-	-	-	-	-	-	-	-	-	-	5.7	280
288	-	-	-	-	-	-	-	-	-	-	-	-	-	-	5.7	288

* SWIHI ** WIHI-A

 98,800 lb  119,700 lb  165,600 lb  211,400 lb  257,300 lb

28.5 ft x 27.9 ft																	360°	85%
148.3 ft + 13.1 ft																		
ft	72.2 ft*			78.7 ft			98.4 ft			118.1 ft			137.8 ft			ft		
	82°	73°	65°	82°	73°	65°	82°	73°	65°	82°	73°	65°	82°	73°	65°			
1,000 lb																		
56	53.6	-	-	-	-	-	-	-	-	-	-	-	-	-	-	56		
64	53.2	-	-	48.1	-	-	38.6	-	-	-	-	-	-	-	-	64		
72	52.3	-	-	47.8	-	-	38.6	-	-	30.0	-	-	22.9	-	-	72		
80	50.6	-	-	47.3	-	-	38.6	-	-	30.0	-	-	22.9	-	-	80		
88	48.8	-	-	46.4	-	-	38.5	-	-	30.0	-	-	22.9	-	-	88		
96	-	40.5	-	-	-	-	38.2	-	-	30.0	-	-	22.9	-	-	96		
104	-	38.3	-	-	-	-	37.8	-	-	30.0	-	-	22.9	-	-	104		
112	-	36.3	-	-	36.3	-	37.2	32.8	-	30.0	25.6	-	22.9	-	-	112		
120	-	-	-	-	34.7	-	-	31.6	-	30.0	25.6	-	22.9	19.0	-	120		
128	-	-	-	-	-	-	-	30.3	-	29.9	25.5	-	22.9	19.0	-	128		
136	-	-	-	-	-	-	-	29.0	-	-	25.3	-	22.9	19.0	-	136		
144	-	-	-	-	-	-	-	-	24.4	-	24.8	-	22.9	19.0	-	144		
152	-	-	-	-	-	-	-	-	23.0	-	24.4	21.5	22.9	19.0	-	152		
160	-	-	-	-	-	-	-	-	22.1	-	23.7	20.4	-	19.0	-	160		
168	-	-	-	-	-	-	-	-	-	-	-	19.5	-	19.0	16.6	168		
176	-	-	-	-	-	-	-	-	-	-	-	18.8	-	19.0	16.4	176		
184	-	-	-	-	-	-	-	-	-	-	-	-	-	-	15.9	184		
192	-	-	-	-	-	-	-	-	-	-	-	-	-	-	15.5	192		
200	-	-	-	-	-	-	-	-	-	-	-	-	-	-	15.0	200		

ft	157.5 ft			177.2 ft			196.9 ft**			216.5 ft			236.2 ft**			ft	
	82°	73°	65°	82°	73°	65°	82°	73°	65°	82°	73°	65°	82°	73°	65°		
1,000 lb																	
80	20.5	-	-	18.5	-	-	-	-	-	-	-	-	-	-	-	80	
88	20.5	-	-	18.4	-	-	14.3	-	-	-	-	-	-	-	-	88	
96	20.5	-	-	18.3	-	-	14.3	-	-	11.2	-	-	-	-	-	96	
104	20.5	-	-	18.2	-	-	14.3	-	-	11.2	-	-	7.7	-	-	104	
112	20.5	-	-	18.1	-	-	14.3	-	-	11.2	-	-	7.7	-	-	112	
120	20.5	-	-	17.8	-	-	14.3	-	-	11.2	-	-	7.7	-	-	120	
128	20.5	-	-	17.6	-	-	14.3	-	-	11.2	-	-	7.7	-	-	128	
136	20.5	16.5	-	17.3	-	-	14.1	-	-	11.2	-	-	7.7	-	-	136	
144	20.4	16.5	-	17.0	14.3	-	14.0	-	-	11.2	-	-	7.7	-	-	144	
152	20.3	16.5	-	16.7	14.3	-	13.9	10.6	-	11.2	-	-	7.7	-	-	152	
160	20.3	16.5	-	16.6	14.3	-	13.7	10.6	-	11.2	7.9	-	7.7	-	-	160	
168	20.1	16.5	-	16.4	14.3	-	13.6	10.6	-	11.2	7.9	-	7.7	4.9	-	168	
176	-	16.5	14.2	16.1	14.1	-	13.5	10.6	-	11.2	7.9	-	7.7	4.9	-	176	
184	-	16.4	13.8	16.1	14.1	12.1	13.3	10.6	-	11.2	7.9	-	7.7	4.9	-	184	
192	-	16.2	13.4	16.1	13.9	11.7	13.2	10.6	-	11.2	7.9	-	7.7	4.9	-	192	
200	-	15.9	13.0	-	13.7	11.3	13.1	10.6	8.6	11.1	7.9	-	7.7	4.9	-	200	
208	-	-	12.8	-	13.4	10.8	13.0	10.6	8.5	11.0	7.9	-	7.7	4.9	-	208	
216	-	-	12.4	-	13.0	10.4	-	10.6	8.4	11.0	7.9	6.2	7.7	4.9	-	216	
224	-	-	-	-	-	10.0	-	10.5	8.3	11.0	7.9	6.2	7.7	4.9	-	224	
232	-	-	-	-	-	9.6	-	10.4	8.1	11.0	7.9	6.2	7.7	4.9	-	232	
240	-	-	-	-	-	-	-	-	7.9	-	7.9	6.2	7.7	4.9	-	240	
248	-	-	-	-	-	-	-	-	7.5	-	7.9	6.2	7.7	4.9	-	248	
256	-	-	-	-	-	-	-	-	7.3	-	7.9	6.2	-	4.9	-	256	
264	-	-	-	-	-	-	-	-	-	-	-	6.1	-	4.9	-	264	
272	-	-	-	-	-	-	-	-	-	-	-	6.0	-	4.9	-	272	

* SWIHI ** WIHI-A

98,800 lb 119,700 lb 165,600 lb 211,400 lb 257,300 lb

28.5 ft x 27.9 ft										360°			85%		
163.1 ft + 13.1 ft															
72.2 ft*		78.7 ft			98.4 ft			118.1 ft			137.8 ft				
82° 73° 65°		82° 73° 65°			82° 73° 65°			82° 73° 65°			82° 73° 65°				
ft	1,000 lb											ft			
64	39.5	-	-	-	-	-	28.9	-	-	-	-	-	64		
72	39.5	-	-	36.6	-	-	28.9	-	-	22.0	-	-	72		
80	39.4	-	-	36.6	-	-	28.9	-	-	22.0	-	-	80		
88	38.8	-	-	36.6	-	-	28.9	-	-	22.0	-	-	88		
96	-	-	-	36.6	-	-	28.9	-	-	22.0	-	-	96		
104	-	31.9	-	-	-	-	28.9	-	-	22.0	-	-	104		
112	-	30.1	-	-	30.1	-	28.9	24.7	-	22.0	-	-	112		
120	-	-	-	-	28.6	-	-	24.7	-	22.0	18.3	-	120		
128	-	-	-	-	-	-	-	24.4	-	22.0	18.3	-	128		
136	-	-	-	-	-	-	-	23.5	-	22.0	18.3	-	136		
144	-	-	-	-	-	-	-	22.7	-	-	18.3	-	144		
152	-	-	-	-	-	-	-	-	19.1	-	18.3	-	152		
160	-	-	-	-	-	-	-	-	18.3	-	18.2	15.9	160		
168	-	-	-	-	-	-	-	-	-	-	15.5	-	168		
176	-	-	-	-	-	-	-	-	-	-	15.1	-	176		
184	-	-	-	-	-	-	-	-	-	-	14.5	-	184		
192	-	-	-	-	-	-	-	-	-	-	-	-	192		
200	-	-	-	-	-	-	-	-	-	-	-	-	200		

157.5 ft		177.2 ft			196.9 ft**			216.5 ft			236.2 ft**		
82° 73° 65°		82° 73° 65°			82° 73° 65°			82° 73° 65°			82° 73° 65°		
ft	1,000 lb											ft	
80	17.9	-	-	-	-	-	-	-	-	-	-	-	80
88	17.9	-	-	13.4	-	-	-	-	-	-	-	-	88
96	17.9	-	-	13.4	-	-	9.9	-	-	-	-	-	96
104	17.8	-	-	13.4	-	-	9.9	-	-	7.5	-	-	104
112	17.6	-	-	13.4	-	-	9.9	-	-	7.5	-	-	112
120	17.6	-	-	13.4	-	-	9.9	-	-	7.5	-	-	120
128	17.4	-	-	13.4	-	-	9.9	-	-	7.5	-	-	128
136	17.2	-	-	13.4	-	-	9.9	-	-	7.5	-	-	136
144	17.0	13.9	-	13.4	-	-	9.9	-	-	7.5	-	-	144
152	16.7	13.9	-	13.2	9.7	-	9.9	-	-	7.5	-	-	152
160	16.5	13.7	-	13.1	9.7	-	9.9	6.6	-	7.5	-	-	160
168	16.2	13.5	-	12.9	9.7	-	9.9	6.6	-	7.5	4.4	-	168
176	16.1	13.3	-	12.8	9.7	-	9.9	6.6	-	7.5	4.4	-	176
184	-	13.0	11.0	12.8	9.7	-	9.9	6.6	-	7.5	4.4	-	184
192	-	12.5	10.5	12.7	9.7	-	9.9	6.6	-	7.5	4.4	-	192
200	-	12.2	9.9	-	9.7	7.6	9.9	6.6	-	7.5	4.4	-	200
208	-	-	9.5	-	9.6	7.3	9.9	6.6	4.9	7.5	4.4	-	208
216	-	-	9.1	-	9.5	7.1	9.9	6.6	4.9	7.5	4.4	-	216
224	-	-	8.7	-	-	7.0	-	6.6	4.9	7.5	4.4	-	224
232	-	-	-	-	-	6.8	-	6.6	4.9	7.5	4.4	-	232
240	-	-	-	-	-	6.5	-	6.6	4.9	-	4.4	-	240
248	-	-	-	-	-	-	-	-	4.7	-	4.4	-	248
256	-	-	-	-	-	-	-	-	4.4	-	4.4	-	256

* SWIHI ** WIHI-A

98,800 lb 119,700 lb 165,600 lb 211,400 lb 257,300 lb

28.5 ft x 27.9 ft																	360°	85%
177.8 ft + 13.1 ft																		
ft	72.2 ft*			78.7 ft			98.4 ft			118.1 ft			137.8 ft			ft		
	82°	73°	65°	82°	73°	65°	82°	73°	65°	82°	73°	65°	82°	73°	65°			
1,000 lb																		
64	28.9	-	-	-	-	-	-	-	-	-	-	-	-	-	-	-	64	
72	28.9	-	-	26.9	-	-	20.5	-	-	-	-	-	-	-	-	-	72	
80	28.9	-	-	26.9	-	-	20.5	-	-	14.8	-	-	16.5	-	-	-	80	
88	28.9	-	-	26.9	-	-	20.5	-	-	14.8	-	-	16.3	-	-	-	88	
96	-	-	-	26.9	-	-	20.5	-	-	14.8	-	-	16.2	-	-	-	96	
104	-	-	-	-	-	-	20.5	-	-	14.8	-	-	15.8	-	-	-	104	
112	-	24.6	-	-	-	-	20.5	-	-	14.8	-	-	15.4	-	-	-	112	
120	-	23.8	-	-	23.1	-	20.5	17.0	-	14.8	-	-	15.2	-	-	-	120	
128	-	-	-	-	22.7	-	-	17.0	-	14.8	11.7	-	14.9	-	-	-	128	
136	-	-	-	-	-	-	-	17.0	-	14.8	11.7	-	14.6	-	-	-	136	
144	-	-	-	-	-	-	-	17.0	-	-	11.7	-	14.3	12.8	-	-	144	
152	-	-	-	-	-	-	-	-	-	-	11.7	-	14.1	12.8	-	-	152	
160	-	-	-	-	-	-	-	-	14.6	-	11.7	-	13.9	12.6	-	-	160	
168	-	-	-	-	-	-	-	-	14.1	-	11.7	10.1	-	12.4	-	-	168	
176	-	-	-	-	-	-	-	-	-	-	10.1	-	-	12.2	-	-	176	
184	-	-	-	-	-	-	-	-	-	-	10.1	-	11.9	9.7	-	-	184	
192	-	-	-	-	-	-	-	-	-	-	10.1	-	-	9.2	-	-	192	
200	-	-	-	-	-	-	-	-	-	-	-	-	-	8.8	-	-	200	
208	-	-	-	-	-	-	-	-	-	-	-	-	-	8.4	-	-	208	

ft	157.5 ft			177.2 ft			196.9 ft**			216.5 ft			ft
	82°	73°	65°	82°	73°	65°	82°	73°	65°	82°	73°	65°	
1,000 lb													
88	12.1	-	-	8.4	-	-	-	-	-	-	-	-	88
96	12.1	-	-	8.4	-	-	5.5	-	-	-	-	-	96
104	12.1	-	-	8.4	-	-	5.5	-	-	3.5	-	-	104
112	12.1	-	-	8.4	-	-	5.5	-	-	3.5	-	-	112
120	12.0	-	-	8.4	-	-	5.5	-	-	3.5	-	-	120
128	11.8	-	-	8.4	-	-	5.5	-	-	3.5	-	-	128
136	11.7	-	-	8.4	-	-	5.5	-	-	3.5	-	-	136
144	11.6	-	-	8.4	-	-	5.5	-	-	3.5	-	-	144
152	11.4	8.8	-	8.4	5.3	-	5.5	-	-	3.5	-	-	152
160	11.2	8.8	-	8.4	5.3	-	5.5	-	-	3.5	-	-	160
168	11.0	8.8	-	8.3	5.3	-	5.5	-	-	3.5	-	-	168
176	10.8	8.8	-	8.2	5.3	-	5.5	-	-	3.5	-	-	176
184	-	8.8	-	8.1	5.3	-	5.5	-	-	3.5	-	-	184
192	-	8.8	7.0	7.9	5.3	-	5.5	-	-	3.5	-	-	192
200	-	8.8	6.7	7.9	5.3	-	5.5	-	-	3.5	-	-	200
208	-	8.7	6.5	-	5.3	3.7	5.5	-	-	3.5	-	-	208
216	-	-	6.4	-	5.3	3.7	5.5	-	-	3.5	-	-	216
224	-	-	6.1	-	5.3	3.7	-	-	-	3.5	-	-	224
232	-	-	5.8	-	-	3.7	-	-	-	3.5	-	-	232
240	-	-	-	-	-	3.6	-	-	-	-	-	-	240
248	-	-	-	-	-	3.5	-	-	-	-	-	-	248

* SWIHI ** WIHI-A

98,800 lb 119,700 lb 165,600 lb 211,400 lb 257,300 lb

28.5 ft x 27.9 ft										360°			85%			
192.6 ft + 13.1 ft																
72.2 ft*		78.7 ft			98.4 ft			118.1 ft			137.8 ft					
82° 73° 65°		82° 73° 65°			82° 73° 65°			82° 73° 65°			82° 73° 65°					
ft	1,000 lb											ft				
72	20.3	-	-	-	-	-	13.7	-	-	-	-	-	-	-	-	72
80	20.3	-	-	-	-	-	13.7	-	-	12.3	-	-	11.2	-	-	80
88	20.3	-	-	-	19.0	-	13.7	-	-	12.3	-	-	11.2	-	-	88
96	-	-	-	-	19.0	-	13.7	-	-	12.3	-	-	11.2	-	-	96
104	-	-	-	-	-	-	13.7	-	-	12.3	-	-	11.1	-	-	104
112	-	17.0	-	-	-	-	13.7	-	-	12.3	-	-	11.0	-	-	112
120	-	17.0	-	-	15.9	-	13.7	-	-	12.3	-	-	10.9	-	-	120
128	-	-	-	-	15.9	-	-	10.6	-	12.3	-	-	10.7	-	-	128
136	-	-	-	-	-	-	-	10.6	-	12.3	9.3	-	10.4	-	-	136
144	-	-	-	-	-	-	-	10.6	-	-	9.3	-	10.3	-	-	144
152	-	-	-	-	-	-	-	10.6	-	-	9.3	-	10.1	7.9	-	152
160	-	-	-	-	-	-	-	-	-	-	9.3	-	9.9	7.9	-	160
168	-	-	-	-	-	-	-	-	-	-	9.3	-	-	7.9	-	168
176	-	-	-	-	-	-	-	-	9.0	-	-	-	-	7.9	-	176
184	-	-	-	-	-	-	-	-	-	-	-	-	-	7.9	-	184
192	-	-	-	-	-	-	-	-	-	-	-	-	-	7.9	6.1	192
200	-	-	-	-	-	-	-	-	-	-	-	-	-	-	5.8	200
208	-	-	-	-	-	-	-	-	-	-	-	-	-	-	5.6	208
216	-	-	-	-	-	-	-	-	-	-	-	-	-	-	5.3	216

157.5 ft		177.2 ft			
82° 73° 65°		82° 73° 65°			
ft	1,000 lb				ft
88	7.5	-	-	-	88
96	7.5	-	-	4.4	96
104	7.5	-	-	4.4	104
112	7.5	-	-	4.4	112
120	7.5	-	-	4.4	120
128	7.5	-	-	4.4	128
136	7.5	-	-	4.4	136
144	7.5	-	-	4.4	144
152	7.5	4.6	-	4.4	152
160	7.3	4.6	-	4.4	160
168	7.3	4.6	-	4.4	168
176	7.3	4.6	-	4.4	176
184	-	4.6	-	4.4	184
192	-	4.6	-	4.4	192
200	-	4.6	-	4.4	200
208	-	4.6	-	-	208

* SWIHI

98,800 lb 119,700 lb 165,600 lb 211,400 lb 257,300 lb

28.5 ft x 27.9 ft													360°			85%		
148.3 ft + 13.1 ft																		
ft	72.2 ft*			78.7 ft			98.4 ft			118.1 ft			137.8 ft			ft		
	82°	73°	65°	82°	73°	65°	82°	73°	65°	82°	73°	65°	82°	73°	65°			
1,000 lb																		
48	53.1	-	-	-	-	-	-	-	-	-	-	-	-	-	-	48		
56	51.2	-	-	48.2	-	-	40.5	-	-	-	-	-	-	-	-	56		
64	49.2	-	-	46.6	-	-	39.5	-	-	32.5	-	-	-	-	-	64		
72	47.0	-	-	45.0	-	-	38.4	-	-	32.2	-	-	25.4	-	-	72		
80	45.2	-	-	43.1	-	-	37.3	-	-	31.4	-	-	25.3	-	-	80		
88	43.5	42.0	-	41.4	-	-	36.1	-	-	30.6	-	-	25.0	-	-	88		
96	-	40.6	-	-	39.4	-	34.8	-	-	29.8	-	-	24.6	-	-	96		
104	-	39.3	-	-	38.2	-	33.7	33.1	-	29.0	-	-	24.2	-	-	104		
112	-	-	-	-	37.0	-	-	31.9	-	28.2	27.3	-	23.8	21.2	-	112		
120	-	-	36.3	-	-	-	-	31.0	-	27.4	26.8	-	23.2	21.2	-	120		
128	-	-	34.7	-	-	34.1	-	30.1	-	26.6	26.1	-	22.8	21.1	-	128		
136	-	-	-	-	-	32.9	-	29.4	28.6	-	25.3	-	22.4	21.0	-	136		
144	-	-	-	-	-	-	-	-	27.8	-	24.6	24.0	21.8	20.7	-	144		
152	-	-	-	-	-	-	-	-	27.0	-	23.9	23.3	-	20.4	18.7	152		
160	-	-	-	-	-	-	-	-	-	-	-	22.7	-	20.0	18.6	160		
168	-	-	-	-	-	-	-	-	-	-	-	22.0	-	19.6	18.5	168		
176	-	-	-	-	-	-	-	-	-	-	-	21.5	-	19.0	18.3	176		
184	-	-	-	-	-	-	-	-	-	-	-	-	-	-	18.0	184		
192	-	-	-	-	-	-	-	-	-	-	-	-	-	-	17.6	192		

ft	157.5 ft			177.2 ft			196.9 ft**			216.5 ft			236.2 ft**			ft
	82°	73°	65°	82°	73°	65°	82°	73°	65°	82°	73°	65°	82°	73°	65°	
1,000 lb																
80	22.2	-	-	18.4	-	-	-	-	-	-	-	-	-	-	-	80
88	21.7	-	-	18.0	-	-	15.1	-	-	-	-	-	-	-	-	88
96	21.3	-	-	17.6	-	-	14.7	-	-	12.4	-	-	9.0	-	-	96
104	20.9	-	-	17.1	-	-	14.4	-	-	12.2	-	-	9.0	-	-	104
112	20.5	-	-	16.7	-	-	14.1	-	-	11.9	-	-	9.0	-	-	112
120	19.9	-	-	16.5	-	-	13.8	-	-	11.8	-	-	9.0	-	-	120
128	19.5	18.2	-	16.2	-	-	13.6	-	-	11.6	-	-	9.0	-	-	128
136	19.1	17.9	-	15.8	15.1	-	13.3	-	-	11.3	-	-	8.8	-	-	136
144	18.6	17.6	-	15.4	14.7	-	13.1	-	-	11.0	-	-	8.6	-	-	144
152	18.2	17.4	-	15.2	14.3	-	13.0	11.7	-	10.8	9.0	-	8.4	-	-	152
160	17.8	17.1	-	14.9	14.0	-	12.7	11.5	-	10.7	9.0	-	8.3	6.0	-	160
168	17.4	16.7	15.5	14.6	13.8	-	12.6	11.3	-	10.4	9.0	-	8.1	6.0	-	168
176	-	16.4	15.3	14.2	13.5	-	12.2	11.2	-	10.2	9.0	-	8.0	6.0	-	176
184	-	16.0	15.0	13.9	13.2	12.4	11.9	11.0	9.7	10.0	9.0	-	7.8	6.0	-	184
192	-	15.5	14.7	-	12.9	12.1	11.7	10.7	9.7	9.9	9.0	-	7.7	6.0	-	192
200	-	-	14.4	-	12.7	11.8	11.1	10.6	9.5	9.8	8.8	7.3	7.6	6.0	-	200
208	-	-	14.2	-	12.4	11.5	11.0	10.4	9.4	9.6	8.7	7.3	7.4	6.0	-	208
216	-	-	13.9	-	12.1	11.3	-	10.2	9.3	9.5	8.6	7.3	7.3	6.0	4.2	216
224	-	-	-	-	-	11.1	-	9.8	9.2	9.4	8.5	7.3	7.3	6.0	4.2	224
232	-	-	-	-	-	10.9	-	9.6	9.0	-	8.3	7.3	7.3	6.0	4.2	232
240	-	-	-	-	-	-	-	-	8.9	-	8.2	7.3	7.3	6.0	4.2	240
248	-	-	-	-	-	-	-	-	8.6	-	8.0	7.1	6.8	5.8	4.2	248
256	-	-	-	-	-	-	-	-	-	-	-	7.1	-	5.7	4.2	256
264	-	-	-	-	-	-	-	-	-	-	-	6.9	-	5.7	4.2	264
272	-	-	-	-	-	-	-	-	-	-	-	6.8	-	-	4.2	272
280	-	-	-	-	-	-	-	-	-	-	-	-	-	-	4.2	280
288	-	-	-	-	-	-	-	-	-	-	-	-	-	-	4.2	288

* SWIHI-SL ** WIHI-A-SL

119,700 lb 165,600 lb 211,400 lb 257,300 lb

SWIHI-SL / WIHI-SL / WIHI-A-SL 0°

AC 350-6

28.5 ft x 27.9 ft													360°			85%		
163.1 ft + 13.1 ft																		
		72.2 ft*			78.7 ft			98.4 ft			118.1 ft			137.8 ft				
		82°	73°	65°	82°	73°	65°	82°	73°	65°	82°	73°	65°	82°	73°	65°		
ft		1,000 lb															ft	
56		40.0	-	-	-	-	-	-	-	-	-	-	-	-	-	-	-	56
64		38.8	-	-	37.5	-	-	30.8	-	-	-	-	-	-	-	-	-	64
72		37.7	-	-	36.4	-	-	30.2	-	-	24.3	-	-	21.4	-	-	-	72
80		36.9	-	-	35.4	-	-	29.4	-	-	24.0	-	-	21.1	-	-	-	80
88		35.6	-	-	34.5	-	-	28.7	-	-	23.6	-	-	20.5	-	-	-	88
96		-	33.8	-	33.4	-	-	28.2	-	-	23.1	-	-	20.0	-	-	-	96
104		-	32.8	-	-	32.0	-	27.6	26.0	-	22.6	-	-	19.6	-	-	-	104
112		-	31.7	-	-	31.0	-	27.1	25.8	-	22.2	19.8	-	19.1	-	-	-	112
120		-	-	-	-	29.9	-	-	25.4	-	21.8	19.8	-	18.7	17.0	-	-	120
128		-	-	29.1	-	-	-	-	24.9	-	21.5	19.8	-	18.4	17.0	-	-	128
136		-	-	28.0	-	-	27.6	-	24.2	-	21.2	19.7	-	17.9	17.0	-	-	136
144		-	-	-	-	-	26.8	-	23.6	22.7	-	19.4	-	17.5	16.7	-	-	144
152		-	-	-	-	-	-	-	-	22.2	-	19.1	17.2	-	16.3	-	-	152
160		-	-	-	-	-	-	-	-	21.7	-	18.9	17.2	-	16.0	14.6	-	160
168		-	-	-	-	-	-	-	-	-	-	-	17.1	-	15.7	14.5	-	168
176		-	-	-	-	-	-	-	-	-	-	-	17.0	-	15.3	14.3	-	176
184		-	-	-	-	-	-	-	-	-	-	-	-	-	-	14.3	-	184
192		-	-	-	-	-	-	-	-	-	-	-	-	-	-	13.8	-	192
200		-	-	-	-	-	-	-	-	-	-	-	-	-	-	13.6	-	200

		157.5 ft			177.2 ft			196.9 ft**			216.5 ft			236.2 ft**				
		82°	73°	65°	82°	73°	65°	82°	73°	65°	82°	73°	65°	82°	73°	65°		
ft		1,000 lb															ft	
80		17.8	-	-	14.5	-	-	-	-	-	-	-	-	-	-	-	-	80
88		17.2	-	-	14.1	-	-	11.0	-	-	-	-	-	-	-	-	-	88
96		16.8	-	-	13.8	-	-	11.0	-	-	8.6	-	-	-	-	-	-	96
104		16.4	-	-	13.4	-	-	10.9	-	-	8.6	-	-	5.5	-	-	-	104
112		15.9	-	-	13.0	-	-	10.8	-	-	8.6	-	-	5.5	-	-	-	112
120		15.5	-	-	12.7	-	-	10.5	-	-	8.5	-	-	5.5	-	-	-	120
128		15.1	-	-	12.4	-	-	10.2	-	-	8.3	-	-	5.5	-	-	-	128
136		14.8	14.0	-	12.0	-	-	10.0	-	-	8.2	-	-	5.5	-	-	-	136
144		14.6	13.7	-	11.7	10.6	-	9.8	-	-	8.1	-	-	5.5	-	-	-	144
152		14.3	13.4	-	11.4	10.6	-	9.7	7.5	-	7.9	-	-	5.5	-	-	-	152
160		14.0	13.1	-	11.3	10.4	-	9.5	7.5	-	7.9	5.3	-	5.5	-	-	-	160
168		13.8	12.9	-	11.1	10.2	-	9.3	7.5	-	7.6	5.3	-	5.4	-	-	-	168
176		-	12.6	11.9	10.8	10.0	-	9.1	7.5	-	7.5	5.3	-	5.3	-	-	-	176
184		-	12.3	11.7	10.8	9.7	8.4	8.9	7.4	-	7.3	5.3	-	5.2	-	-	-	184
192		-	12.1	11.4	-	9.5	8.4	8.8	7.3	-	7.0	5.3	-	5.1	-	-	-	192
200		-	12.0	11.1	-	9.3	8.4	8.7	7.3	5.5	6.9	5.3	-	5.1	-	-	-	200
208		-	-	10.9	-	9.2	8.3	8.2	7.2	5.5	6.8	5.3	3.5	5.0	-	-	-	208
216		-	-	10.6	-	9.0	8.2	-	7.1	5.5	6.8	5.3	3.5	4.9	-	-	-	216
224		-	-	-	-	-	8.1	-	7.1	5.5	6.7	5.3	3.5	4.7	-	-	-	224
232		-	-	-	-	-	7.9	-	6.8	5.5	-	5.3	3.5	4.6	-	-	-	232
240		-	-	-	-	-	7.8	-	-	5.5	-	5.3	3.5	4.6	-	-	-	240
248		-	-	-	-	-	-	-	-	5.5	-	5.3	3.5	4.6	-	-	-	248
256		-	-	-	-	-	-	-	-	5.5	-	-	3.5	-	-	-	-	256
264		-	-	-	-	-	-	-	-	-	-	-	3.5	-	-	-	-	264
272		-	-	-	-	-	-	-	-	-	-	-	3.5	-	-	-	-	272
280		-	-	-	-	-	-	-	-	-	-	-	3.5	-	-	-	-	280

* SWIHI-SL ** WIHI-A-SL

119,700 lb 165,600 lb 211,400 lb 257,300 lb

28.5 ft x 27.9 ft																	360°			85%	
177.8 ft + 13.1 ft																					
		72.2 ft*			78.7 ft			98.4 ft			118.1 ft			137.8 ft							
		82°	73°	65°	82°	73°	65°	82°	73°	65°	82°	73°	65°	82°	73°	65°					
ft		1,000 lb															ft				
56		29.1	-	-	-	-	-	-	-	-	-	-	-	-	-	-	56				
64		28.0	-	-	27.1	-	-	21.9	-	-	-	-	-	-	-	-	64				
72		26.9	-	-	26.3	-	-	21.4	-	-	16.5	-	-	-	-	-	72				
80		26.1	-	-	25.4	-	-	20.8	-	-	16.5	-	-	15.1	-	-	80				
88		25.4	-	-	24.7	-	-	20.1	-	-	16.0	-	-	14.6	-	-	88				
96		-	-	-	24.2	-	-	19.6	-	-	15.7	-	-	14.1	-	-	96				
104		-	22.9	-	-	-	-	19.1	-	-	15.4	-	-	13.6	-	-	104				
112		-	22.2	-	-	21.6	-	18.7	17.4	-	15.0	-	-	13.2	-	-	112				
120		-	21.7	-	-	21.2	-	-	16.9	-	14.5	12.6	-	12.8	-	-	120				
128		-	-	-	-	20.7	-	-	16.6	-	14.2	12.5	-	12.4	11.5	-	128				
136		-	-	19.7	-	-	-	-	16.2	-	13.9	12.4	-	12.0	11.1	-	136				
144		-	-	19.2	-	-	18.9	-	15.9	-	-	12.2	-	11.8	10.7	-	144				
152		-	-	-	-	-	18.4	-	-	14.5	-	12.1	-	11.6	10.3	-	152				
160		-	-	-	-	-	-	-	-	14.2	-	11.9	10.4	-	10.1	-	160				
168		-	-	-	-	-	-	-	-	14.0	-	11.8	10.4	-	9.9	9.1	168				
176		-	-	-	-	-	-	-	-	-	-	11.8	10.4	-	9.7	8.9	176				
184		-	-	-	-	-	-	-	-	-	-	-	10.2	-	-	8.6	184				
192		-	-	-	-	-	-	-	-	-	-	-	-	-	-	8.3	192				
200		-	-	-	-	-	-	-	-	-	-	-	-	-	-	8.2	200				
208		-	-	-	-	-	-	-	-	-	-	-	-	-	-	8.0	208				

157.5 ft																	177.2 ft			196.9 ft**			216.5 ft		
		82°	73°	65°	82°	73°	65°	82°	73°	65°	82°	73°	65°	82°	73°	65°									
ft		1,000 lb															ft								
80		12.5	-	-	-	-	-	-	-	-	-	-	-	-	-	-	80								
88		11.9	-	-	9.2	-	-	-	-	-	-	-	-	-	-	-	88								
96		11.4	-	-	8.9	-	-	6.4	-	-	-	-	-	-	-	-	96								
104		11.0	-	-	8.6	-	-	6.4	-	-	4.4	-	-	-	-	-	104								
112		10.6	-	-	8.4	-	-	6.4	-	-	4.4	-	-	-	-	-	112								
120		10.3	-	-	8.0	-	-	6.1	-	-	4.4	-	-	-	-	-	120								
128		10.0	-	-	7.6	-	-	5.9	-	-	4.4	-	-	-	-	-	128								
136		9.8	8.7	-	7.3	-	-	5.8	-	-	4.2	-	-	-	-	-	136								
144		9.4	8.4	-	7.1	-	-	5.6	-	-	4.1	-	-	-	-	-	144								
152		9.0	8.1	-	6.8	5.7	-	5.5	-	-	4.0	-	-	-	-	-	152								
160		9.0	7.9	-	6.7	5.6	-	5.4	-	-	4.0	-	-	-	-	-	160								
168		8.8	7.6	-	6.5	5.4	-	5.2	-	-	3.9	-	-	-	-	-	168								
176		8.6	7.3	-	6.4	5.3	-	5.1	-	-	3.8	-	-	-	-	-	176								
184		-	7.2	6.4	6.3	5.1	-	4.7	-	-	3.5	-	-	-	-	-	184								
192		-	7.0	6.1	6.1	4.9	3.9	4.6	-	-	3.3	-	-	-	-	-	192								
200		-	6.9	6.0	-	4.7	3.7	4.5	-	-	-	-	-	-	-	-	200								
208		-	-	5.9	-	4.6	3.7	4.1	-	-	-	-	-	-	-	-	208								
216		-	-	5.7	-	4.6	3.5	4.0	-	-	-	-	-	-	-	-	216								
224		-	-	5.6	-	-	3.5	-	-	-	-	-	-	-	-	-	224								
232		-	-	-	-	-	3.5	-	-	-	-	-	-	-	-	-	232								
240		-	-	-	-	-	3.4	-	-	-	-	-	-	-	-	-	240								

* SWIHI-SL ** WIHI-A-SL

119,700 lb 165,600 lb 211,400 lb 257,300 lb

		28.5 ft x 27.9 ft									360°			85%			
		192.6 ft + 13.1 ft															
		72.2 ft*			78.7 ft			98.4 ft			118.1 ft			137.8 ft			
		82°	73°	65°	82°	73°	65°	82°	73°	65°	82°	73°	65°	82°	73°	65°	
ft		1,000 lb															ft
64		20.9	-	-	-	-	-	-	-	-	-	-	-	-	-	-	64
72		20.1	-	-	19.6	-	-	14.8	-	-	13.2	-	-	-	-	-	72
80		19.3	-	-	18.9	-	-	14.7	-	-	13.0	-	-	10.7	-	-	80
88		18.7	-	-	18.3	-	-	14.5	-	-	12.7	-	-	10.2	-	-	88
96		-	-	-	17.8	-	-	14.2	-	-	12.3	-	-	9.8	-	-	96
104		-	16.5	-	-	-	-	13.8	-	-	11.8	-	-	9.4	-	-	104
112		-	15.8	-	-	15.6	-	13.4	11.0	-	11.5	-	-	9.0	-	-	112
120		-	15.3	-	-	15.2	-	13.1	11.0	-	11.3	9.5	-	8.8	-	-	120
128		-	-	-	-	14.8	-	-	11.0	-	10.9	9.4	-	8.5	-	-	128
136		-	-	-	-	-	-	-	10.8	-	10.6	9.3	-	8.2	7.3	-	136
144		-	-	13.3	-	-	-	-	10.7	-	-	9.1	-	7.9	7.0	-	144
152		-	-	12.7	-	-	12.7	-	-	8.8	-	8.8	-	7.7	6.6	-	152
160		-	-	-	-	-	12.4	-	-	8.8	-	8.7	-	-	6.5	-	160
168		-	-	-	-	-	-	-	-	8.8	-	8.5	7.1	-	6.3	-	168
176		-	-	-	-	-	-	-	-	8.6	-	-	7.1	-	6.0	-	176
184		-	-	-	-	-	-	-	-	-	-	-	6.9	-	5.8	5.1	184
192		-	-	-	-	-	-	-	-	-	-	-	6.8	-	-	4.8	192
200		-	-	-	-	-	-	-	-	-	-	-	6.8	-	-	4.7	200
208		-	-	-	-	-	-	-	-	-	-	-	-	-	-	4.6	208
216		-	-	-	-	-	-	-	-	-	-	-	-	-	-	4.4	216

		157.5 ft			177.2 ft			
		82°	73°	65°	82°	73°	65°	
ft		1,000 lb						ft
80		8.1	-	-	-	-	-	80
88		7.8	-	-	5.1	-	-	88
96		7.6	-	-	5.1	-	-	96
104		7.3	-	-	5.0	-	-	104
112		7.0	-	-	4.8	-	-	112
120		6.7	-	-	4.7	-	-	120
128		6.3	-	-	4.4	-	-	128
136		6.2	-	-	4.2	-	-	136
144		6.0	4.6	-	4.0	-	-	144
152		5.7	4.6	-	3.7	-	-	152
160		5.6	4.5	-	3.6	-	-	160
168		5.4	4.3	-	3.4	-	-	168
176		5.3	4.0	-	-	-	-	176
184		-	3.9	-	-	-	-	184
192		-	3.7	-	-	-	-	192
200		-	3.7	-	-	-	-	200
208		-	3.6	-	-	-	-	208

* SWIHI-SL

119,700 lb 165,600 lb 211,400 lb 257,300 lb

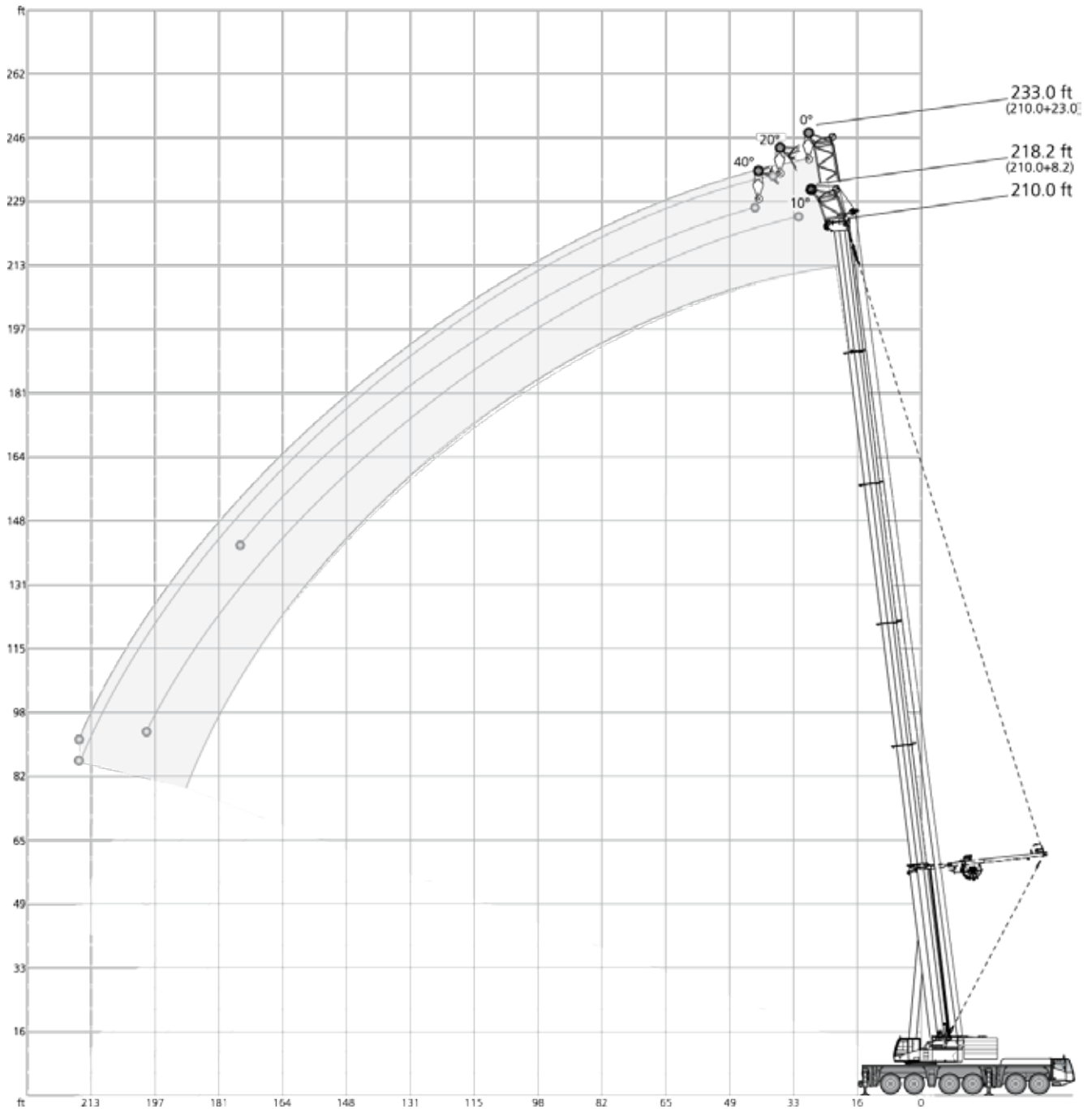
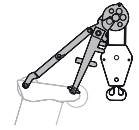

28.5 ft x 27.9 ft												360°				85%	
		59.7 ft				74.5 ft				89.2 ft							
		8.2 ft		23.0 ft*		8.2 ft		23.0 ft*		8.2 ft		23.0 ft*					
		10°	0°	20°	40°	10°	0°	20°	40°	10°	0°	20°	40°				
ft												1,000 lb				ft	
12	148.6	145.4	-	-	-	-	-	-	-	-	-	-	-	12			
14	148.6	133.3	-	-	-	148.6	-	-	-	-	-	-	-	14			
16	148.6	121.6	-	-	-	148.6	135.7	-	-	-	-	-	-	16			
18	148.2	111.1	-	-	-	148.6	123.8	-	-	148.6	-	-	-	18			
20	147.4	101.3	53.9	-	-	148.6	112.7	-	-	148.6	122.7	-	-	20			
24	143.9	86.9	49.2	-	-	147.7	97.2	51.6	-	148.2	105.9	-	-	24			
28	140.4	75.7	45.4	33.5	-	144.2	85.2	48.0	34.2	146.9	93.1	50.2	-	28			
32	137.1	65.4	42.3	31.9	-	140.5	76.3	44.7	32.9	143.8	83.4	47.1	33.5	32			
36	133.9	59.1	39.4	30.6	-	137.6	68.0	42.2	31.7	140.3	76.1	44.5	32.3	36			
40	131.0	53.6	36.7	29.4	-	135.0	60.4	39.8	30.5	137.0	69.1	42.0	31.4	40			
48	128.0	43.7	33.0	27.6	-	129.0	51.7	35.8	28.8	130.0	57.4	38.1	29.6	48			
56	110.6	37.4	29.8	26.3	-	115.9	43.8	32.7	27.4	115.7	50.2	35.0	28.3	56			
64	-	32.3	27.4	-	-	98.7	38.2	30.0	26.4	100.3	43.1	32.3	27.1	64			
72	-	28.5	26.0	-	-	79.9	34.0	28.0	25.8	86.9	38.7	30.0	26.0	72			
88	-	-	-	-	-	-	28.0	25.8	-	37.5	31.3	26.8	-	88			
104	-	-	-	-	-	-	-	-	-	-	26.9	25.6	-	104			

104.0 ft				133.5 ft				163.1 ft									
ft												1,000 lb				ft	
20	148.6	126.3	-	-	-	-	-	-	-	-	-	-	-	20			
24	148.3	111.5	-	-	-	-	-	-	-	-	-	-	-	24			
28	146.7	98.8	51.4	-	-	-	-	-	-	-	-	-	-	28			
32	144.4	88.9	48.4	-	-	140.2	90.2	-	-	-	-	-	-	32			
36	141.7	81.3	46.0	32.9	-	133.3	83.6	47.9	-	-	-	-	-	36			
40	138.9	74.5	43.8	31.8	-	125.3	77.4	45.8	32.5	96.2	73.4	-	-	40			
48	131.0	63.2	40.1	30.3	-	108.1	67.4	42.2	31.0	85.9	65.9	42.4	31.0	48			
56	115.0	54.6	36.7	29.0	-	94.6	60.4	39.2	29.7	77.4	59.8	39.7	30.0	56			
64	98.4	48.6	34.2	27.8	-	82.7	53.4	36.6	28.7	70.1	54.9	37.3	28.9	64			
72	85.2	42.5	32.0	26.9	-	74.2	48.4	34.2	27.6	63.6	50.6	35.3	28.0	72			
80	77.9	38.5	29.9	26.2	-	66.2	44.6	32.6	26.8	57.4	46.4	33.7	27.2	80			
88	69.0	35.2	28.4	25.7	-	59.1	40.7	31.0	26.3	52.4	43.0	32.0	26.5	88			
96	58.6	32.0	27.1	25.6	-	53.6	37.3	29.3	25.7	47.7	40.4	30.7	26.0	96			
104	41.8	29.8	26.1	19.4	-	48.8	34.9	28.2	25.5	43.2	37.9	29.6	25.5	104			
112	-	27.7	17.8	-	-	44.7	32.7	27.3	25.4	38.8	35.4	28.4	25.1	112			
120	-	16.7	-	-	-	40.7	30.6	26.3	25.4	35.8	33.1	27.4	24.8	120			
128	-	-	-	-	-	34.6	28.8	25.7	-	32.7	30.9	26.6	24.7	128			
144	-	-	-	-	-	-	25.9	25.4	-	27.2	26.8	25.1	24.7	144			
160	-	-	-	-	-	-	-	-	-	18.7	23.1	22.6	-	160			
176	-	-	-	-	-	-	-	-	-	-	15.9	-	-	176			

191.6 ft				210.0 ft													
ft												1,000 lb				ft	
48	64.1	48.0	-	-	-	-	-	-	-	-	-	-	-	48			
56	58.9	43.6	37.2	-	-	48.8	41.7	-	-	-	-	-	-	56			
64	54.3	39.9	35.4	28.4	-	45.0	39.1	34.9	-	-	-	-	-	64			
72	50.1	36.7	33.8	27.6	-	41.7	36.4	33.3	27.4	-	-	-	-	72			
80	46.7	34.2	32.1	26.8	-	38.9	33.8	31.7	26.8	-	-	-	-	80			
88	43.4	31.8	30.2	26.3	-	36.5	31.8	30.1	26.1	-	-	-	-	88			
96	40.1	29.4	28.2	25.7	-	34.2	29.9	28.5	25.4	-	-	-	-	96			
104	37.6	27.5	26.4	25.1	-	32.1	28.0	26.9	24.7	-	-	-	-	104			
112	35.1	25.9	24.8	24.4	-	30.1	26.2	25.3	24.0	-	-	-	-	112			
120	32.7	24.5	23.5	23.2	-	28.4	24.8	23.9	23.3	-	-	-	-	120			
128	30.4	22.9	22.2	22.0	-	26.6	23.5	22.7	22.5	-	-	-	-	128			
136	28.1	21.3	21.0	20.8	-	24.9	22.3	21.6	21.4	-	-	-	-	136			
144	26.1	20.1	19.9	19.7	-	23.2	21.1	20.7	20.5	-	-	-	-	144			
152	24.2	19.0	18.8	18.6	-	21.6	19.9	19.7	19.5	-	-	-	-	152			
160	22.2	17.8	17.7	17.7	-	20.3	18.8	18.6	18.6	-	-	-	-	160			
168	20.5	16.7	16.7	16.7	-	19.0	17.8	17.7	17.7	-	-	-	-	168			
184	14.7	14.7	14.7	-	-	16.4	15.8	15.8	15.8	-	-	-	-	184			
200	-	11.7	-	-	-	12.0	13.8	13.9	-	-	-	-	-	200			
216	-	-	-	-	-	-	9.6	10.1	-	-	-	-	-	216			

28.5 ft x 27.9 ft													360°				85%							
133.5 ft													163.1 ft				192.6 ft							
8.2 ft													23.0 ft*				8.2 ft				23.0 ft*			
10°													0°				20°				40°			
ft	1,000 lb												ft											
24	148.0	-	-	-	-	-	-	-	-	-	-	-	-	-	-	-	-	-	-	-	-	24		
28	146.7	110.5	-	-	-	-	-	-	-	-	-	-	-	-	-	-	-	-	-	-	-	28		
32	144.3	101.1	-	-	-	104.0	88.2	-	-	-	-	-	-	-	-	-	-	-	-	-	-	32		
36	141.2	93.2	49.3	-	-	101.4	85.7	-	-	-	-	64.4	-	-	-	-	-	-	-	-	-	36		
40	137.8	86.0	47.1	33.2	-	98.8	82.9	48.2	-	-	-	62.8	53.4	-	-	-	-	-	-	-	-	40		
48	126.2	75.0	43.5	31.6	-	94.1	75.1	44.7	32.1	-	-	59.9	51.0	43.6	-	-	-	-	-	-	-	48		
56	108.3	65.9	40.4	30.2	-	89.9	68.2	41.8	30.8	-	-	57.0	48.7	41.2	30.6	-	-	-	-	-	-	56		
64	94.2	57.7	37.6	29.1	-	86.1	62.3	39.5	29.8	-	-	54.7	46.7	39.0	29.7	-	-	-	-	-	-	64		
72	81.8	52.4	35.3	28.0	-	80.2	56.3	37.1	28.7	-	-	52.3	44.8	37.1	28.7	-	-	-	-	-	-	72		
80	71.4	47.5	33.4	27.3	-	71.1	51.7	35.0	27.8	-	-	49.9	42.9	35.5	28.1	-	-	-	-	-	-	80		
88	61.9	42.8	31.6	26.6	-	62.0	48.2	33.4	27.0	-	-	48.0	41.1	33.8	27.3	-	-	-	-	-	-	88		
96	54.0	39.2	29.9	26.0	-	54.2	44.7	31.9	26.6	-	-	46.3	39.6	32.4	26.6	-	-	-	-	-	-	96		
104	47.6	36.5	28.8	25.6	-	47.8	41.4	30.5	26.1	-	-	44.6	38.3	31.3	26.1	-	-	-	-	-	-	104		
112	41.5	33.8	27.7	25.3	-	41.8	38.2	29.1	25.6	-	-	42.8	37.0	30.4	25.8	-	-	-	-	-	-	112		
120	35.4	31.5	26.6	-	-	37.1	36.2	28.2	25.3	-	-	38.7	35.8	29.3	25.2	-	-	-	-	-	-	120		
128	27.4	29.5	25.8	-	-	32.7	33.7	27.4	25.1	-	-	34.7	34.0	28.3	24.7	-	-	-	-	-	-	128		
136	-	27.9	25.4	-	-	29.0	30.3	26.4	25.0	-	-	31.0	31.4	27.3	24.3	-	-	-	-	-	-	136		
144	-	21.3	22.4	-	-	25.7	26.8	25.6	24.9	-	-	27.7	28.4	26.7	24.3	-	-	-	-	-	-	144		
152	-	-	-	-	-	20.7	24.1	24.5	-	-	-	24.8	25.6	25.9	24.3	-	-	-	-	-	-	152		
160	-	-	-	-	-	-	20.9	21.6	-	-	-	22.2	22.8	23.6	23.6	-	-	-	-	-	-	160		
168	-	-	-	-	-	-	16.1	17.0	-	-	-	19.9	20.5	21.1	21.3	-	-	-	-	-	-	168		
176	-	-	-	-	-	-	-	-	-	-	-	16.8	18.4	18.8	-	-	-	-	-	-	-	176		
184	-	-	-	-	-	-	-	-	-	-	-	-	16.4	16.9	-	-	-	-	-	-	-	184		
192	-	-	-	-	-	-	-	-	-	-	-	-	13.3	14.1	-	-	-	-	-	-	-	192		

210.0 ft													
ft	1,000 lb												ft
40	48.5	41.3	-	-	-	-	-	-	-	-	-	-	40
48	46.0	39.5	39.9	-	-	-	-	-	-	-	-	-	48
56	43.8	37.8	38.0	30.2	-	-	-	-	-	-	-	-	56
64	41.8	36.0	36.3	29.1	-	-	-	-	-	-	-	-	64
72	39.9	34.4	34.6	28.2	-	-	-	-	-	-	-	-	72
80	38.1	33.1	33.3	27.5	-	-	-	-	-	-	-	-	80
88	36.4	31.6	32.0	26.9	-	-	-	-	-	-	-	-	88
96	34.9	30.2	30.6	26.3	-	-	-	-	-	-	-	-	96
104	33.7	29.1	29.4	25.6	-	-	-	-	-	-	-	-	104
112	32.3	28.2	28.2	25.1	-	-	-	-	-	-	-	-	112
120	31.1	27.1	27.2	24.8	-	-	-	-	-	-	-	-	120
128	29.9	26.0	26.3	24.5	-	-	-	-	-	-	-	-	128
136	28.8	24.9	25.3	24.1	-	-	-	-	-	-	-	-	136
144	27.6	24.1	24.3	23.8	-	-	-	-	-	-	-	-	144
152	24.8	23.3	23.7	23.3	-	-	-	-	-	-	-	-	152
160	22.2	22.4	22.8	22.8	-	-	-	-	-	-	-	-	160
168	19.7	20.4	21.1	21.3	-	-	-	-	-	-	-	-	168
176	17.5	18.2	18.8	19.1	-	-	-	-	-	-	-	-	176
184	15.6	16.3	16.7	-	-	-	-	-	-	-	-	-	184
192	13.1	14.4	14.9	-	-	-	-	-	-	-	-	-	192
200	9.2	12.7	13.1	-	-	-	-	-	-	-	-	-	200
208	-	10.0	10.5	-	-	-	-	-	-	-	-	-	208
216	-	6.6	7.3	-	-	-	-	-	-	-	-	-	216

* MS-A-SL

119,700 lb 165,600 lb 211,400 lb 257,300 lb

Basic machine

Equipment carrier

Engine 430-4	MTU; Output 430 kW (585 HP), torque 2750 Nm, certifications in accordance with Tier 4F, CARB; Exhaust system made of stainless steel with SCR catalytic converter. 166 gallons; Fuel: Diesel; Supplies carrier and crane (13 gallons buffer tank at crane).
Transmission AS16INT	ZF AS-Tronic; Automatic transmission with integrated hydraulic retarder brake, 16 forward speeds and 2 reverse; 2-stage transfer case with switchable off-road gear and switchable longitudinal lock.
Axles 12 x 8 x 10	12 x 8 x 10; 6 axles, axles 2, 4-6 driven and equipped with selectable transverse lock, axles 4 and 5 with selectable longitudinal lock; Axles 1-3, 5+6 steered, axle 4 liftable.
Suspension	Hydropneumatic suspension with axle load compensation; Hydraulically lockable; Manual or automatic levelling alternatively.
Steering	Dual circuit hydro semiblock steering with emergency steering pump; Active rear axle steering with different steering programs.
Brakes	Pneumatic dual circuit service brake, acting on all wheels; Disc brakes; Hydraulic retarder integrated into transmission as sustained-action brake; Additional exhaust brake and constant choke valve; Spring-loaded parking brake.
Tires size 385/95 R25 (14.00R25)	Tires size 385/95 R25 (14.00R25); Steel rims 9,50-25/1,7"; TechKing ETCRANE 170F or similar.
Cab 2880	Type 9.45 ft; Adjustable driver seat with seat heating, armrests and pneumatic suspension; Co-driver's seat; Steering wheel height and tilt adjustable; Power door windows; Tinted glass; Radio-preparation.
Heating engine-dependent	Engine-dependent warm water heating with 12 kW heating power.
Aircondition	Aircondition for carrier cab with 7 kW cooling power.
Cruise control	Automatic speed control including automatic brake control.
Drive lights	With low beam, upper beam.
Outriggers	H-4-Point design; 4 outriggers telescopic; Vertical and horizontal movement fully hydraulic; Manual or automatic levelling alternatively; 4 outrigger bases: 9.0 ft, 18.2 ft, 23.0 ft and 27.9 ft.
Outrigger pads 038	4 round outrigger pads A = 4.1 ft ² with transport position at vertical cylinder.
Outrigger load indicator	Displayed in LMI crane cab.
Outrigger basis monitoring	Individual monitoring of horizontal stroke; Deviation warning in crane cab.
Central lubrication	Central auto lube for all lubrication points at carrier.
Electronic immobiliser system	Prevents uncontrolled carrier mobilisation; Incl. 2 electronic keys and 4 ignition keys.
Contour safety marking	Continuous reflective strips on the sides of the chassis and on the rear.

Equipment superstructure

Engine 210-4	MTU; Output 210 kW (286 HP), torque 1150 Nm, certifications in accordance with Tier 4F, CARB; Exhaust system made of stainless steel with SCR catalytic converter.
Telescopic boom HA64	44.9 ft – 210.0 ft; Single cylinder telescoping system, automatic telescoping; Attachments for all equipment and extensions; 6 sheaves integrated in boom head.
Boom luffing	1 luffing cylinder with automatic lowering brake valve.
Rotary drive	1 slewing gear unit with spring-loaded multi-disc brake.
H1	Hoist with spring-loaded multi-disc brake; Twist prevention for rope; Resolver (hoist rotation indicator).
Counterweight 76,500 lb	Counterweight 76,500 lb, 4 pieces; Automatic rigging system; Expandable to max. 257,300 lb.
Control system	Enabling 4 simultaneous working movements; Electric pilot controls via 2 two-axis joysticks; Different control modes selectable for hydraulic circuits.
Operator aids	IC-1, with integrated electronic load moment indicator in accordance with EN13000; Color display; Displaying of current operating conditions, load charts, fault indicator; Signal lights indicating LMI-load; Crane data logger.
Working range limiter	Displaying and programmability of the work range limits by IC-1.
Hook height indication	Displaying and programmability of the hook height by IC-1.
Cab 088	Type 2.87 ft; Tilt infinitely variable 20°; Seat heating; Sliding windows in door and rear; Fold-out front window; Extendable side pedestal, foldable front pedestal; Handrails; Tinted safety glass; Pull-down sun visor and light curtains; Radio-preparation.
Heating engine-dependent	Engine-dependent warm water heating with 12 kW heating power.
Aircondition	Aircondition in crane cab with 7 kW cooling power.
Anemometer	Removable, to be used with all extensions.

Additional equipment

Carrier

Additional fuel tank Additional fuel tank 79 gallons, for total 245 gallons Diesel.

Superstructure

Quick connection main boom (HA) Hydraulic bolt extractors and hydraulic and electric quick couplings for fast (dis-) assembly; Incl. transport storage for luffing cylinder.

Heavy lift attachment 4 additional sheaves = 10 sheaves integrated in boom head; Enable max. capacity of 441,000 lb.

SL Superlift; Capacity increasing boom guy support; Incl. transport storage.

2. hoist (H2) 2. hoist; Spring-loaded multi-disc brake; Resolver (hoist rotation indicator); Rope twist prevention; Incl. quick couplings and transport storage at crane tail; Enables 2-hook operation with all extensions except WIHI; Exclusive luffing tackle unit.

Additional counterweight 180,800 lb Additional counterweight 180,800 lb; Counterweight plates e-l; For max. 257,300 lb.

Handling

HR Hydraulic winch for reeving assistance.

Fall-from-height protection system boom base section Working at height fall-arrest system at the main boom base section.

Fall-from-height protection system boom base section + SL Working at height fall-arrest system at the main boom base section and SL.

Extensions

WIHI-A 236.2 ft 236.2 ft; Luffing jib, complete kit; Increments 19.7 ft; With integrated manual offset section 20° / 40°; System dimensions Q1313, Q1309; 2-sheave head; Includes SF51, LF27, H2 incl. disconnectable luffing tackle unit.

SF-A 167.3 ft 167.3 ft; Strong fixed jib; Increments 19.7 ft; With integrated manual offset section 20° / 40°; System dimensions Q1313, Q1309; 2-sheave head; Includes LF27.

LF-A 88.6 ft 88.6 ft; Light fixed jib; Increments 19.7 ft; With integrated manual offset section 20° / 40°; System dimension Q1309; 2-sheave head.

HAV 65.6 ft 37.4 ft / 65.6 ft; Extendable swing-away jib incl. folding adapter, manual offset 20° / 40°; 1-sheave head; Incl. transport storage (folding adapter remains at boom head).

MS (runner) 9.8 ft; 2-parted, fixed assembly jib; 3-sheave head; Operation of runner head also with selected LF and WIHI lengths (SWIHI).

Hook Blocks

Hook block 200-9-23-D 200-9-23-D (4,410 lb); Hook block with ramshorn hook; white with red signal stripes.

Hook block 160-7-23-D 160-7-23-D (3,750 lb); Hook block with ramshorn hook; white with red signal stripes.

Hook block 125-5-23-D 125-5-23-D (2,650 lb); Hook block with ramshorn hook; white with red signal stripes.

Hook block 80-3-23-D 80-3-23-D (2,320 lb); Hook block with ramshorn hook; white with red signal stripes.

Hook block 40-1-23-D 40-1-23-D (1,650 lb); Hook block with ramshorn hook; white with red signal stripes.

Hook 12-0V-E 12-0V-E (1,100 lb); Single hook with vertical swivel; red.

Further additional equipment on request!

Weight data may deviate from posted values based on road / travel configuration, equipment configuration, and component weight tolerances.

December 2017. Product specifications and prices are subject to change without notice or obligation. The photographs and/or drawings in this document are for illustrative purposes only. Refer to the appropriate Operator's Manual for instructions on the proper use of this equipment. Failure to follow the corresponding Operator's Manual when using our equipment or to otherwise act responsibly may result in serious injury or death. The only warranty applicable to our equipment is the standard written warranty applicable to the particular product and sale and Terex makes no other warranty, express or implied. Products and services listed may be trademarks, service marks or trade-names of Terex Corporation and/or its subsidiaries in the USA and other countries. All rights are reserved. Terex, Demag and Above, Ahead, Always are trademarks of or licensed by Terex Corporation or its subsidiaries.

© Terex Cranes 2017

TEREX CRANES GERMANY GMBH

Dinglerstraße 24
66482 Zweibrücken
Germany

E info.cranes@terex.com
T +49 6332 830

www.terex.com/cranes
linkedin.com/company/demagmobilecranes
facebook.com/TerexCranes
youtube.com/TerexCranesMarketing

DEMAG[®]
BY TEREX 